

CHEMOSAT[®]

Hepatic Delivery System

For Melphalan Hydrochloride for Injection

Instructions for Use

en

EU DOCUMENT ONLY

Delcath.
Systems, Inc. 

**Concentrating the Power
of Chemotherapy**

120040.H

Effective Date: 2023-07-26

TABLE OF CONTENTS

ASSEMBLED SYSTEM – FIGURE 1 3

SUPPLIED DISPOSABLE COMPONENTS – FIGURE 2 4

DESCRIPTION OF SYSTEM COMPONENTS 5

INDICATIONS FOR USE 6

INTENDED PURPOSE 6

RECOMMENDED DOSE OF MELPHALAN HYDROCHLORIDE 6

MELPHALAN HYDROCHLORIDE DOSE MANAGEMENT 6

PATIENT TARGET GROUP AND SELECTION CRITERIA 6

INFORMATION THE TREATING DOCTOR SHOULD CONVEY TO THE PATIENT 7

RESIDUAL RISKS 7

CONTRAINDICATIONS 7

WARNINGS 8

PRECAUTIONS 8

STORAGE, HANDLING AND DISPOSAL 9

ADVERSE EVENTS AND COMPLICATIONS 9

LOCATION OF PROCEDURE 9

INTENDED USER (PROCEDURAL TEAM) 9

APPROXIMATE PROCEDURE TIMES 10

PREPARATION: PRIOR TO TREATMENT 10

PREPARING AND PRIMING THE HEMOFILTRATION CIRCUIT 12

PLACING THE CATHETERS 21

ESTABLISHING ANTIKOAGULATION & PLACING ISOFUSE® ISOLATION ASPIRATION CATHETER 22

CONNECTING CATHETERS TO HEMOFILTRATION CIRCUIT 23

ISOLATING THE INFERIOR VENA CAVA 23

BRINGING HEMOFILTRATION CARTRIDGES ON LINE 24

SETUP DRUG DELIVERY SYSTEM AND START EXTRACORPOREAL FILTRATION 24

ENDING EXTRACORPOREAL CIRCULATION 25

CATHETER REMOVAL 25

NORMALIZATION OF COAGULATION STATUS FOR SHEATH REMOVAL 25

SAFETY AND CLINICAL PERFORMANCE 26

REPORT SERIOUS INCIDENTS 26

PROCEDURE FLOWCHART - FIGURE 29 27

LIMITED WARRANTY 28

ASSEMBLED SYSTEM – FIGURE 1

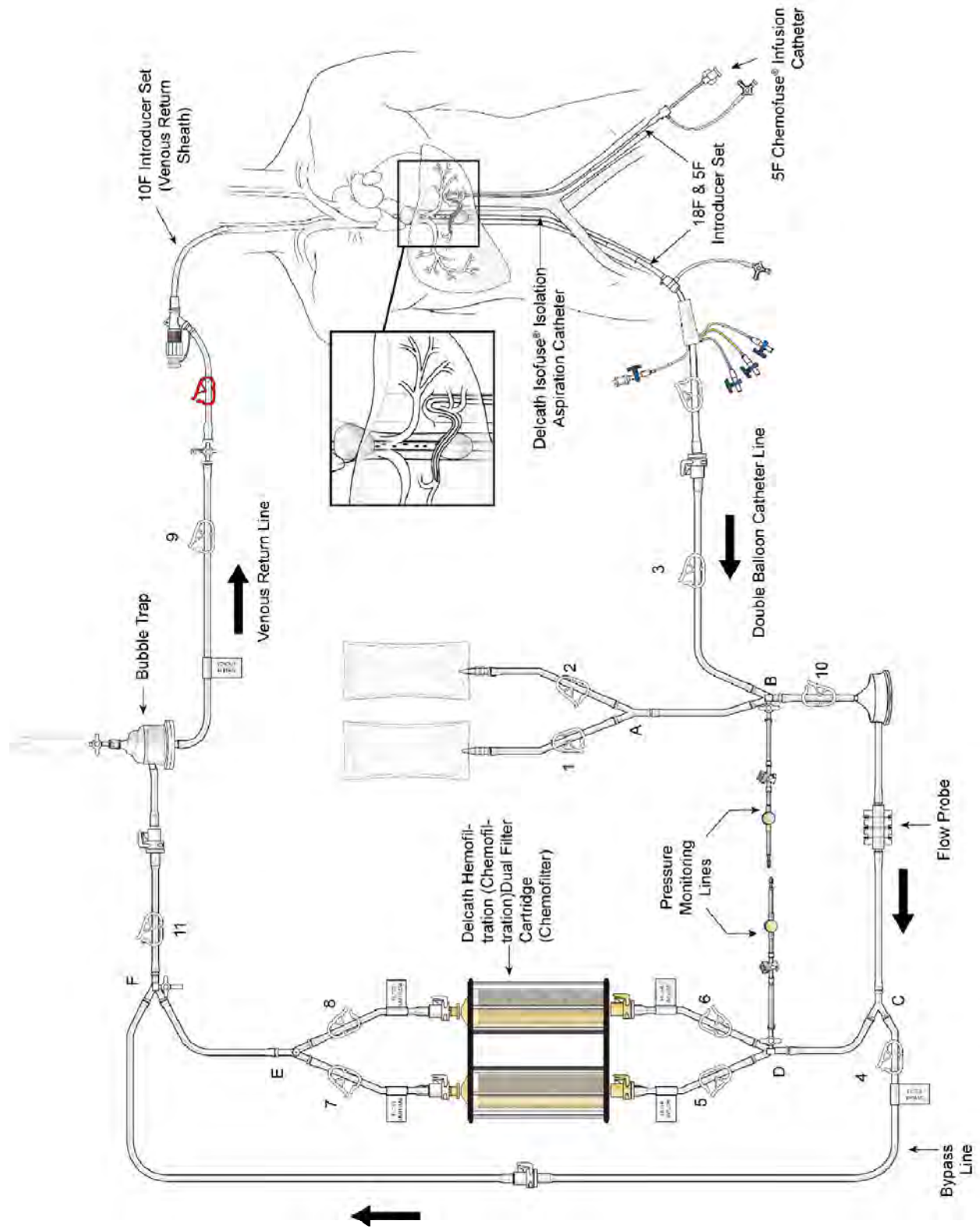

SUPPLIED DISPOSABLE COMPONENTS – FIGURE 2

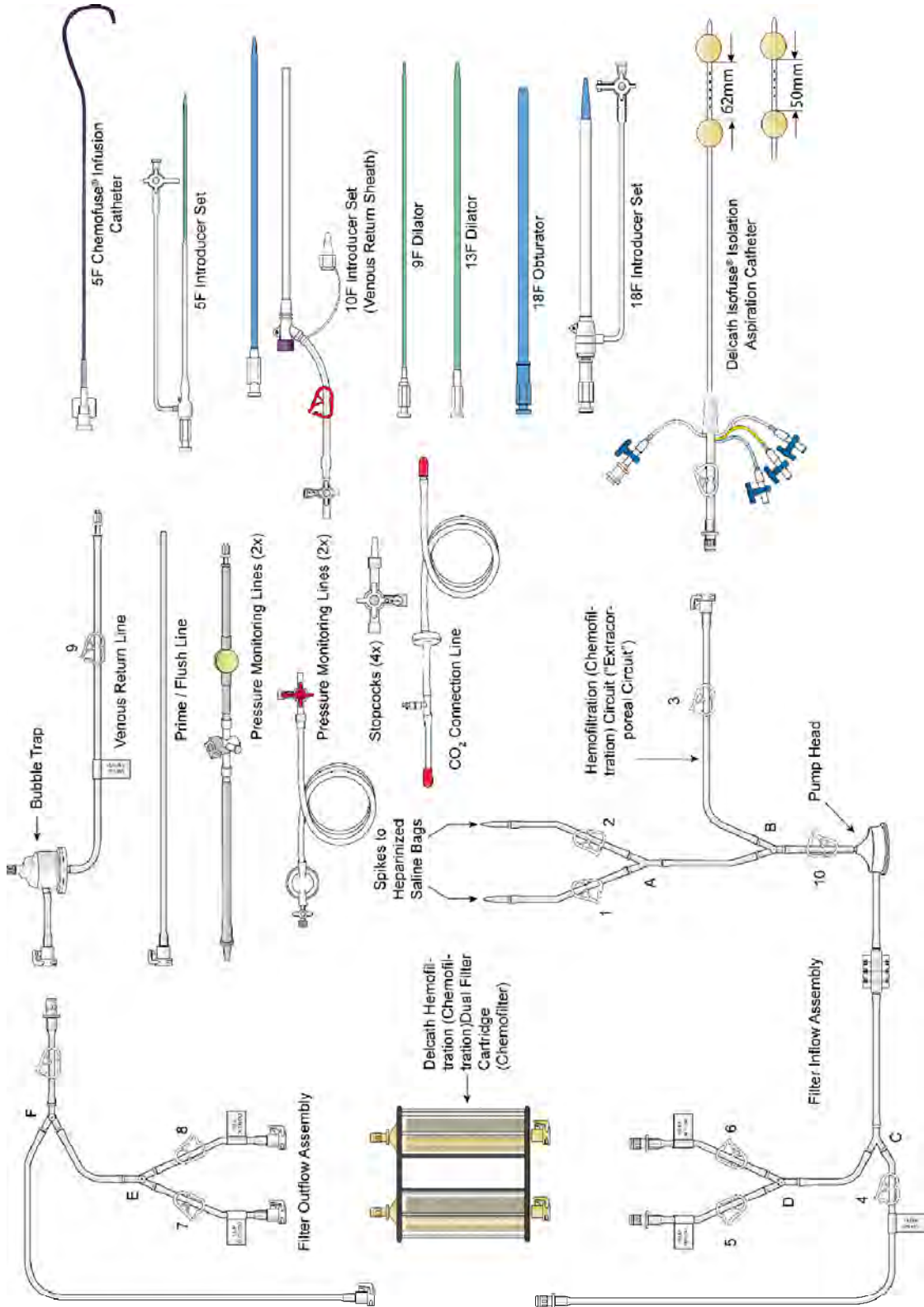

DELCATH CHEMOSAT® HEPATIC DELIVERY SYSTEM

COMPLETE REQUIRED TRAINING BEFORE USING THIS DEVICE FOR THE FIRST TIME. ENSURE YOU COMPLETELY READ AND UNDERSTAND THE INSTRUCTIONS FOR USE.



An electronic version of this IFU is also available online at www.chemosat.com

DESCRIPTION OF SYSTEM COMPONENTS

The Delcath CHEMOSAT® Hepatic Delivery System consists of a closed circuit of catheters and drug specific filters utilized to deliver a chemotherapeutic agent (melphalan hydrochloride) to the (hepatic) artery of the liver and to lower the concentration of the agent in the blood before it is returned to systemic circulation. A schematic overview of how the Delcath CHEMOSAT® Hepatic Delivery System components work together is presented in Figure 1: Assembled System. The system is designed to be used with a Medtronic Bio-Console® 560 Speed Controller System and TX50P Flow Transducer.

1. Delcath Isofuse® Isolation Aspiration Catheter

-- 16F (shaft) polyurethane double balloon catheter that is placed in the retro-hepatic inferior vena cava to isolate the hepatic venous blood and transport it to the extracorporeal Hemofiltration Circuit for filtration. The catheter has one large (central) drainage lumen and four accessory ports. Due to variation in the length of the retro-hepatic segment of the inferior vena cava and relative positions of hepatic and renal veins, the Isofuse® Catheter is available in two different balloon configurations: 50 mm or 62 mm between the two balloons.

Using pre-operative computed tomography (CT) imaging, or by performing an inferior vena cavogram prior to placement of the Isofuse® Catheter, estimate the length of the retro-hepatic segment of the inferior vena cava and the relative positions of hepatic and renal veins in order to determine the optimum Isofuse® Catheter balloon spacing: 50mm or 62mm.

Two (2) of the accessory ports are used to inflate low-pressure occlusion balloons, which are inflated independently to occlude the inferior vena cava above and below the hepatic veins. When inflated, the cephalic (superior – blue port) balloon obstructs the inferior vena cava above the hepatic veins and the caudal (inferior – yellow port) balloon obstructs the inferior vena cava below the hepatic veins, thus isolating hepatic venous blood in the fenestrated segment between the balloons.

The large drainage lumen with a quick connect fitting is a conduit to the fenestrations between the two occlusion-balloons. The fenestrations allow the hepatic venous blood to flow into the drainage lumen and exit the catheter at the proximal end.

The third accessory (translucent) port labeled “CONTRAST” is for injections of iodinated contrast medium through the fenestrations, to check catheter position.

The fourth accessory port (white) is used for over-the-guidewire (OTW) introduction and positioning of the catheter in the retro-hepatic inferior vena cava. This lumen also has a small port opening along the catheter shaft positioned inferior to the caudal balloon and exits at the distal tip, to allow

inferior vena cava blood, proximal to the caudal balloon, to bypass the occluded segment of the inferior vena cava and flow into the right atrium.

2. Accessory Pack

- 9F and 13F Dilator Set --These over-the-wire dilators are used to widen the subcutaneous space and venous entry site in preparation for the placement of the 18F Introducer Set.
- 18F Introducer Set (Sheath and Dilator) -- The 18F introducer sheath and coaxial dilator are to be placed over a wire; the dilator is removed and the sheath is available for the insertion of the Isofuse® Catheter or the 18F Obturator.
- 18F Obturator -- An 18F obturator is used to occlude and support the 18F sheath lumen when it is not in use, and upon removal of the Isofuse® Catheter at the end of the procedure.
- 5F Introducer Set (Sheath & Dilator) -- A 5F hemostasis sheath is used to facilitate the introduction of the 5F Chemofuse® Chemo Delivery Catheter through the femoral artery.
- 10F Introducer Set (Venous Return Sheath) -- A 10F sheath used to return the filtered hepatic venous blood through the internal jugular vein. A 3-way high-flow stopcock is included as part of the 10F Introducer Set. The high-flow stopcock is attached to the Venous Return Sheath and then to the male connector of the Hemofiltration Circuit, if required. This sheath may also be used for hydration. A 10F obturator is included for insertion through the valve post placement.

3. 5F Chemofuse® Infusion Catheter

-- 5F arterial catheter is used to deliver chemotherapeutic agent (melphalan hydrochloride) into the proper hepatic artery or, it can be used to coaxially introduce a microcatheter (not provided by Delcath), if, at the discretion of the Interventional Radiologist, a microcatheter is preferred for selective catheter tip placement for the drug infusion. The following microcatheters have been qualified for use with the CHEMOSAT® Hepatic Delivery System - select one from the microcatheters below. See microcatheter manufacturer's Instructions for Use. These microcatheters are NOT PROVIDED by Delcath:

- Merit Maestro (Merit Medical Systems, Inc., So. Jordan, UT, USA)
- Boston Scientific Renegade Hi-Flo (Boston Scientific Corp., Natick, MA, USA)
- Terumo Progreat (Terumo Medical Corp., Somerset, NJ, USA)

4. Delcath Hemofiltration (Chemofiltration) Dual Filter Cartridge (Chemofilter)

-- One single-use Dual Filter Cartridge designed with the filter cartridges arranged in parallel to lower the concentration of chemotherapeutic agent (melphalan hydrochloride) from the blood. The cartridge frame comes with a built-in pole clamp.

5. Hemofiltration (Chemofiltration) Circuit

(“Extracorporeal Circuit”) -- The Hemofiltration (Chemofiltration) Circuit is used to transport the hepatic venous blood, which has been isolated by the Isofuse® Catheter and aspirated into the fenestration lumen, through the Hemofiltration (Chemofiltration) Cartridges and back to the patient through the Venous Return Sheath. Connections are provided for infusion of normal saline. This circuit includes:

- Medtronic BP-50 Bio-Pump® Centrifugal Pump (“Pump Head”), a disposable pump head to be used with a pump console manufactured by Medtronic, Inc. - see manufacturer's Instructions for Use for Pump Head. (Note: The Medtronic, Inc. Bio-Console 560 (extracorporeal blood pumping) System is required for use with the CHEMOSAT® Hepatic Delivery System: This is NOT PROVIDED by Delcath).

- Medtronic Bio-Probe® DP-38P blood flow monitoring insert (“Flow Probe”), a disposable flow probe to be used with a blood flow monitoring transducer manufactured by Medtronic, Inc. - see manufacturer’s Instructions for Use for Flow Probe. The Flow Probe is used to measure the rate of blood flow during the procedure. (Note: The Medtronic Bio-Probe TX50P blood flow monitoring transducer is required for use with the CHEMOSAT® Hepatic Delivery System: This is NOT PROVIDED by Delcath).

6. Carbon Dioxide (CO₂) Connection Line -- The CO₂ Connection Line is used to deliver sterile CO₂ gas to the Hemofiltration Cartridges to aid in priming/debubbling the filter cartridge, prior to the start of the procedure. The CO₂ Line has no patient contact.

WARNING

Only the Components Provided in the CHEMOSAT® Hepatic Delivery System Or Specified By Delcath In The “NOT INCLUDED” Box Below Are to Be Used to Create the Circuit. There Should Be No Substitutions. The Circuit Has Not Been Validated For Use With Other Components.

Do not disassemble the components provided in the CHEMOSAT® Hepatic Delivery System as this may damage the components.

NOT INCLUDED:

- Chemotherapeutic Agent (Melphalan Hydrochloride)
- Bubble Trap holder
- Medtronic Bio-Console 560 Speed Controller System (“Pump”)
- Medtronic Bio-Probe TX50P (“Flow Transducer”)
- CO₂ Supply for Priming Dual Filter
- Drug Injector: must be able to inject at a rate of 25 mL/minute
- Drug Delivery Disposables:
 - One (1) Medrad 150mL Syringe (Polypropylene (PP)-Barrel & Polyisoprene-Plunger) or equivalent
 - Two (2) Intravenous Administration Set with spike & drip chamber (Polyvinylchloride (PVC)-tubing, Acrylonitrile butadiene styrene (ABS) & Polyethylene (PE)-Drip Chamber & Polycarbonate (PC)-Luer) or equivalent
 - One (1) - 48” injector lines (PVC-Tubing & PC-Luer) or equivalent
 - Five (5) 3-way stopcocks (PC-body, High Density Polyethylene (HDPE) or Acetal-Handles) or equivalent
 - Three (3) 20 mL syringes (PP-Barrel & Polyisoprene-Plunger) or equivalent
- Microcatheters (Maximal Distal End OD = 2.8F) – for Selective Drug Infusion (at Interventional Radiologist discretion). Select one from Delcath qualified microcatheters listed below:
 - Merit Maestro (Merit Medical Systems, Inc., So. Jordan, UT, USA)
 - BSC Renegade Hi-Flo (Boston-Scientific Corp.; Natick, MA, USA)
 - Terumo Progreat (Terumo Medical Corp., Somerset, NJ, USA)

INDICATIONS FOR USE

The Delcath CHEMOSAT® Hepatic Delivery System is used for percutaneous intra-arterial administration of chemotherapeutic agent (melphalan hydrochloride) for perfusion of the liver with subsequent extracorporeal filtration of the regional (hepatic) venous blood, lowering the concentration of chemotherapeutic agent in the blood before returning it to the systemic venous circulation.

INTENDED PURPOSE

The intended purpose of the CHEMOSAT® Hepatic Delivery System is to be used to administer the chemotherapeutic agent, melphalan, to treat unresectable cancer of the liver.

RECOMMENDED DOSE OF MELPHALAN HYDROCHLORIDE

The use of melphalan to treat unresectable primary or metastatic hepatic tumours represent an unlicensed indication.

The recommended dose is 3.0 mg/kg based on ideal body weight (IBW), infused over 30 minutes, with a maximum absolute dose of 220 mg during a single treatment. A dose escalation study performed by Delcath supports the safe use of melphalan at 3.0 mg/kg, as does the published literature.

The maximum absolute dose of 220 mg melphalan during a single treatment should not be exceeded.

MELPHALAN HYDROCHLORIDE DOSE MANAGEMENT

Evidence from the literature indicates that patients with unresectable primary or metastatic hepatic tumours receive between 1-8 treatments and possibly more, with CHEMOSAT®/melphalan (up to 220 mg melphalan/treatment), depending on the patient’s clinical and radiologic response.

There should be at least a 5-6 week gap after treatment with CHEMOSAT® before another treatment is considered. Delays in treatment until recovery from toxicities and a dosage reduction to 2.5 mg/kg, or 2.0 mg/kg IBW, are permitted.

Toxicities should have resolved to grade 2 or less, with the exception of hepatic toxicity due to underlying disease which should resolve to baseline, before additional treatments are considered. A dosage reduction to 2.0 mg/kg IBW should be considered for subsequent treatments for the following reasons:

- Grade 4 neutropenia of >5 days duration despite growth factor support or associated with neutropenic fever
- Grade 4 thrombocytopenia of >5 days duration or associated with a haemorrhage that required a transfusion
- Grade 4 anaemia of >48 hours duration
- Grade 3 or 4 major non-hematologic organ toxicity not corrected within 24 hours of the procedure (excluding fever, nausea, and weight gain); for hepatic toxicity, grade 4 bilirubin of any duration, and doubling of liver function test values (AST, ALT, and total bilirubin) above the baseline value

CHEMOSAT®/Melphalan treatment should be permanently discontinued if patients have persistent toxicity that has not resolved to grade 2, or less, by 8 weeks following treatment.

PATIENT TARGET GROUP AND SELECTION CRITERIA

The intended patient population is adults with surgically unresectable primary or metastatic cancer of the liver.

THE PATIENT SELECTION PROCESS SHOULD BE PERFORMED IN ACCORDANCE WITH EACH INSTITUTION’S GUIDELINES AND RECOMMENDATIONS PROVIDED DURING THE TRAINING OF NEW CENTERS.

INFORMATION THE TREATING DOCTOR SHOULD CONVEY TO THE PATIENT

The CHEMOSAT® Hepatic Delivery System consists of catheters and filters that may cause side effects during treatment or within several days after treatment. The catheters are inserted in the patient's body through large blood vessels after general anaesthesia. Serious side effects from the anaesthesia and catheter placement may occur. Other side effects may occur that are associated with the filters used during treatment. The filters will remove the majority of the chemotherapeutic agent from the patient's blood, as well as, some platelets, red blood cells and clotting factors, causing an increased risk of bleeding during and after treatment. This bleeding can be severe. The treating doctor will monitor the patient very closely during and after treatment, and administer blood products, if needed. The filters will also remove chemicals from the blood that affect blood pressure. Medications may be administered to help keep the blood pressure within normal limits during treatment.

The chemotherapeutic agent may harm an unborn child. Women must not undergo treatment if pregnant, trying to become pregnant or are breast-feeding. Women of childbearing potential should be advised to use effective contraception during treatment and for 6 months after the final treatment. Women who become pregnant during treatment should advise the treating doctor immediately. Men should not father a child while being treated or for 6 months after the last treatment.

Other possible risks related to the use of the CHEMOSAT® Hepatic Delivery System and chemotherapeutic agent are:

- Bleeding in the brain: Blood thinners will be administered during treatment to prevent the formation of blood clots. The blood thinner itself might cause bleeding in the patient's body, such as the nose or places where catheters or needles have been inserted into blood vessels. Patients with a history of brain abnormalities e.g., stroke or brain tumours have an increased risk of bleeding in their brain, but this rarely occurs. Treatment will be discontinued if there is a serious reaction to the blood thinner medication.
 - Catheter leakage or blockage: Chemotherapeutic agent leakage from the catheters into body areas other than the liver could result in an overdose, but this is rare. Symptoms of an overdose include severe nausea and vomiting, decreased consciousness, effects on the nervous system, damage to the gastrointestinal tract or kidneys, and difficulty breathing. Catheter blockage may result in a lower dose of the chemotherapeutic agent being delivered to the liver. The patient will be monitored throughout treatment for any evidence of catheter leakage or blockage.
 - Lung collapse, bleeding, or increased heart rate due to the catheter placed in the neck: These risks are serious, but they rarely occur and are usually easily treated. If the catheter causes the lung to collapse, it may require the temporary placement of an additional tube into the lung to allow it to heal.
 - Abnormal heart rhythm during treatment: The patient's heart rhythm will be closely monitored during treatment.
 - Swollen legs and shortness of breath after treatment: This may be due to fluids received during treatment. Drugs and / or oxygen may be administered to treat any potential fluid overload.
 - Clot formation during or after treatment: A clot in the blood vessel can dislodge and be carried by the blood stream to obstruct another vessel in the lungs, brain, gastrointestinal tract, kidneys, or leg. The patient's coagulation status will be monitored closely during and after the procedure.
 - Insufficient blood flow to the brain: This leads to poor oxygen supply to the brain and brain cell death.
 - Abdominal pain or discomfort after treatment: This pain will diminish over time and may last from a few days to a few weeks.
- Low blood pressure: There may be periods of low blood pressure during the course of the procedure. The patient's blood pressure will be closely monitored and there are methods to manage this.

For additional information to be conveyed to the patient with respect to risks, contraindications and undesirable side effects, please refer to the Residual Risks, Warnings, Contraindications, Precautions and Adverse events and Complications sections below.

RESIDUAL RISKS

Blood Sample Collection

Blood sample collection involves placing a needle into the patient's blood vessel. This may cause some discomfort or bruising. The blood vessel may swell, or blood may clot in the blood vessel. A minor infection or bleeding may rarely occur. This can be easily treated.

General Anesthesia

The side effects of general anesthesia include nausea, muscle aches, or headache. These are common side effects but are usually not severe and resolve within a few hours.

Blood Product Transfusion

Transfusions of blood products may carry some rare risks such as allergic reactions which can be mild or severe or the risk of disease transmission such as hepatitis or HIV (viruses carried in the blood).

DEHP Exposure

The CHEMOSAT® Hepatic Delivery System contains DEHP, a plasticizer (softener), that is commonly added to plastics (such as polyvinyl chloride or PVC) to make them more flexible. Plastics and plasticizers are used throughout the medical device industry. Plasticizers are not chemically linked to the plastic and over time can leach out of the plastic. DEHP exposure has shown negative effects in animal models, particularly on the male reproductive system. While human exposure levels and adverse effects have not been well defined, the industry recognizes DEHP as a risk that can be averted by limiting the exposure of patients to DEHP.

Latex Exposure

The CHEMOSAT® Hepatic Delivery System contains natural rubber latex. This may cause allergic reactions. Natural rubber proteins cause allergic reactions in some people and begin within minutes after exposure. Latex allergic reactions may include hives, itching, stuffy or runny nose. Asthma symptoms may include wheezing, chest tightness and difficulty breathing. The most severe latex allergy can result in severe breathing difficulty and/or a decrease in blood pressure (shock). Allergic skin reactions can occur following direct contact with latex proteins in, for example, latex glove products. Symptoms may include immediate itching, redness and swelling of skin that touched the item containing latex proteins.

CONTRAINDICATIONS

- Liver failure or portal hypertension.
- Active intracranial metastases or brain lesions with a propensity to bleed as determined by imaging.
- History of allergies or known hypersensitivity to a component, material, or drug utilized with the CHEMOSAT® Hepatic Delivery System including:
 - Heparin
 - Angiographic contrast medium
 - Natural rubber latex component of the product
 - Melphalan hydrochloride

WARNINGS

PLEASE CAREFULLY READ AND UNDERSTAND THE LIST OF WARNINGS BELOW AS SERIOUS INJURY, ILLNESS OR DEATH OF THE PATIENT CAN OCCUR IF THESE WARNINGS ARE NOT PROPERLY FOLLOWED.

IN CASE OF MALFUNCTIONING PARTS OR PRODUCT, PLEASE CONTACT DELCATH WITHIN TEN (10) DAYS OF THE APPARENT MALFUNCTION. PLEASE CONTACT DELCATH CUSTOMER SERVICE, THE NUMBER CAN BE FOUND ON THE BACK COVER OF THIS IFU.

WARNINGS RELATING TO THE USE OF MELPHALAN HYDROCHLORIDE

- It is the doctor's responsibility to give due consideration to the details of the melphalan marketing authorization in deciding whether treatment with melphalan is appropriate for the patient in his/her care. The melphalan Summary of Product Characteristics (SmPC) must be consulted.
- The dose of melphalan should be assessed according to the individual patient's weight and clinical circumstances.
- Dual cartridge filter efficiency studies demonstrate that the level of melphalan in blood returned to the patient post-filtration is reduced by approximately 95%. Systemic exposure of melphalan can occur. Related side effects that might occur are listed in the melphalan SmPC.
- Due to the known cytotoxic, mutagenic, embryotoxic (and possible teratogenic) properties, melphalan should not be used during pregnancy, women should not breastfeed, and women/men of childbearing potential should use adequate contraceptive measures, as outlined in the SmPC.

WARNINGS RELATING TO THE USE OF CHEMOSAT®

- The CHEMOSAT® Hepatic Delivery System must not be used in patients who have undergone surgery or medical treatment of the liver within 4 weeks, unless the treating doctor can justify otherwise.
- Screen for prior surgeries that could potentially affect normal hepatic biliary/vascular anatomy (e.g., Whipples Procedure). If the common bile duct is re-implanted, there is an increased risk of biliary tree infection. If the vascular anatomy (especially hepatic arterial supply) is affected, there could be an increased risk of mis-infusion and reflux of chemotherapeutic agent.
- For patients with 50% or greater tumour burden by medical imaging, a biopsy of the non-involved parenchyma must be performed to show that it is histologically normal. Clinical judgment and biopsy results should be used to guide the decision on whether to perform the procedure.
- Patients on chronic anti-coagulation therapy (e.g., Coumadin), the therapy must be discontinued and switched to short-acting agent for the ease of reversal. Patients should avoid drugs effecting platelet functions such as aspirin, or non-steroidal anti-inflammatory drugs (NSAID), starting one week before the procedure. Anti-coagulation therapy may be resumed post-operatively, as indicated, once hemostasis has been restored and no bleeding complication is observed.
- Patients with a history of hypertension receiving angiotensin converting enzyme inhibitors or calcium channel blockers must temporarily discontinue these drugs at least five drug half-lives before the procedure. Short-acting antihypertensive regimen may be used to manage hypertension as needed. After the procedure, previous antihypertensive regimen may be restored under guidance of treating physicians.

- When the catheter is placed intravascularly, it must only be manipulated under fluoroscopic observation. Do not advance or retract the Isofuse® Catheter unless both balloons are fully deflated, except when positioning the inflated cephalad balloon at the junction of the inferior vena cava and right atrium (with the caudal balloon fully deflated). If resistance is met during manipulation, determine the cause of the resistance before proceeding.
- When the 3-way high flow stopcock is used to attach the Venous Return Sheath to the male connector of the Hemofiltration Circuit, ensure that the stopcock is fully open to minimize back pressure and maximize flow through the stopcock. ("OFF" handle of stopcock turned 90° to flow path.)
- Use caution to avoid air embolism while performing this procedure. Never use air or any gaseous medium to inflate the Isofuse® Catheter balloons.
- Contents are supplied STERILE. Inspect prior to use to verify that no damage has occurred during shipping. Do not use if sterile barrier is damaged. If damage is found, please contact Delcath Customer Service.
- All components are for single patient use only. Do not reuse, reprocess or resterilise. Reuse, reprocessing or resterilisation may compromise the structural integrity of the device and/or lead to device failure which, in turn, may result in patient injury, illness, or death. Reuse, reprocessing, or resterilisation may also create a risk of contamination of the device and/or cause patient infection or cross-infection, including, but not limited to, the transmission of infectious disease(s) from one patient to another. Contamination of the device may lead to injury, illness, or death of the patient.

PRECAUTIONS

PRECAUTIONS RELATING TO THE USE OF MELPHALAN HYDROCHLORIDE

- See melphalan SmPC for contraindications regarding use.
- See melphalan SmPC for side effects related to the drug therapy.
- Melphalan should be used immediately after reconstitution. Refer to section 6.6 of the melphalan SmPC ("Special precautions for disposal and other handling").

PRECAUTIONS RELATING TO THE USE OF CHEMOSAT®

- The CHEMOSAT® Hepatic Delivery System is for use only by qualified personnel properly trained and familiar with the procedure in accordance with the Instructions for Use.
- Caution: The CHEMOSAT® Hepatic Delivery System contains natural rubber latex which may cause allergic reactions.
- Women who are pre-menopausal (have had a period within the last 12 months) must receive appropriate hormonal suppression to prevent potential bleeding as a result of the procedure.
- The safety and effectiveness of the use of the CHEMOSAT® Hepatic Delivery System on pregnant women and pediatric patients has not been established.
- Patients should be evaluated for gastric acid hypersecretion (e.g., untreated gastrinoma) and clinically managed as indicated.
- In order to avoid mis-infusion of the drug into gastrointestinal branches originating from the hepatic artery, careful angiographic examination is required, followed by embolization as indicated. During infusion the catheter tip must be placed distal to the origins of any gastrointestinal branches that may not have been embolized.



WARNING

If the Perfusion Of Melphalan Cannot Be Isolated From The Systemic Circulation, Stop The Drug Infusion Immediately.

- Adequate anticoagulation is required throughout the procedure to prevent intravascular thrombosis and to assure unimpeded flow through the extracorporeal circuit and filters. (See Coagulation Control below).
- During the procedure, the arterial blood pressure must be closely monitored as there will be significant decrease of blood pressure related to:
 - o Initial occlusion of the inferior vena cava by the balloons
 - o The filters coming on line in the extracorporeal circuit
 Prompt intervention must be administered as described below under Blood Pressure Control.
- Hepatic artery spasm may occur and potentially cause reflux of the infusate into more proximal non-embolized gastrointestinal branches. In order to avoid such reflux, the hepatic artery must periodically be checked angiographically for spasm. To relieve hepatic artery spasm, which occurs infrequently, use a 50-100 mcg/injection of intra-arterial nitroglycerin locally to relieve spasm. If spasm does not resolve, the procedure must be stopped.
- The following clinical effects have been observed during the procedure:
 - o Decreased platelet counts occur in a majority of patients. Transfusion is required as clinically indicated. The CHEMOSAT® Hepatic Delivery System must not be administered in patients with platelets <75,000 cells/mm³.
 - o Decreased hemoglobin occurs in a majority of patients. Transfusion is required as clinically indicated. The CHEMOSAT® Hepatic Delivery System should not be used on patients with hemoglobin ≤ 10 g/dL.
 - o Prolongation of activated partial thromboplastin time is an intended effect of heparin administration during the procedure; however, since removal of platelets and clotting factors by the filters can increase the risk of bleeding, anticoagulation must be reversed promptly by the administration of protamine sulfate, Fresh Frozen Plasma and cryoprecipitate should be administered as clinically indicated to correct remaining coagulopathy. The CHEMOSAT® Hepatic Delivery System must not be used on patients with uncorrectable coagulopathies.
 - o Decreased serum albumin occurs frequently. Specific corrective intervention is seldom required.
 - o Decreased blood calcium (hypocalcemia) occurs frequently. As with other less frequent electrolyte disturbances, replacement is required when clinically indicated.
 - o Elevated hepatic transaminases (alanine aminotransferase, aspartate aminotransferase), with or without hyperbilirubinemia, occur. They are self-limiting. No intervention is required.

STORAGE, HANDLING AND DISPOSAL

The CHEMOSAT® Hepatic Delivery System is best kept dry and at room temperature (60°F (15°C) to 80°F (27°C)). Please avoid leaving the CHEMOSAT® Hepatic Delivery System stored at temperatures below 32°F (0°C) and up to 131°F (55°C) for more than 24 hours. The CHEMOSAT® Hepatic Delivery System must also be kept away from sunlight.

	Keep Dry
	Keep Away from Sunlight
	Do not use if package is damaged

THE CHEMOSAT® HEPATIC DELIVERY SYSTEM OR COMPONENTS SHOULD BE DISPOSED OF IN ACCORDANCE WITH YOUR INSTITUTION'S GUIDELINES AND PROTOCOLS FOR DISPOSING BIOHAZARDOUS MATERIALS.

ADVERSE EVENTS AND COMPLICATIONS

In a Phase 3 Ocular and Cutaneous Melanoma Trial, clinically significant (Grade 3-4) adverse events that were observed in >35% of patients in descending order of frequency for the CHEMOSAT® Hepatic Delivery System that occurred within the first 72 hours after the procedure were the following:

Platelet count decreased (69%), Hemoglobin decreased (60%), Blood Albumin decreased (37.1%), aPTT prolonged (31.0%), Blood Calcium decreased (21.4%), AST increased (20%), INR increased (20%), Lymphocyte decreased (12.9%), ALT increased (8.6%), Blood Bilirubin Increased (10%), Blood Potassium decreased (10%), Troponin increased (7.1%).

LOCATION OF PROCEDURE

The procedure must be performed in an appropriately equipped interventional radiology suite with fluoroscopy or an operating room designed and equipped similarly. Resuscitation personnel, equipment, and medications must be immediately available.

INTENDED USER (PROCEDURAL TEAM)

The required procedural team members should be determined by the facility based on institutional experience and clinical judgment. The operating team performing the procedure must include, at a minimum:

- A qualified medical/surgical oncologist experienced in the monitoring of toxicities of chemotherapy and who is responsible for the complete medical management of the patient, including, but not limited to, pre- and post-operative care. The medical/surgical oncologist may also be responsible for monitoring the patient during the immediate post-procedure period.

- O** The medical/surgical oncologist will also play a unique role in communicating about chemotherapeutic agent (melphalan hydrochloride) and the CHEMOSAT® Hepatic Delivery System risks and coordinating with other oncologists and key health care professionals responsible for patient follow-up care and monitoring for post-procedure toxicities.
- IR** A qualified interventional radiologist with the knowledge, skills, experience, and hospital privileges required to perform advanced vascular interventional procedures.
- PF** A qualified perfusionist to establish, monitor, and control the extracorporeal pump and veno-venous bypass circuit.
- AN** A qualified anesthetist (anesthesiologist) and/or nurse anesthetist responsible for the management of sedation, analgesia, respiratory and cardiovascular support.
- PH** A qualified pharmacist, on call during the procedure, to reconstitute the chemotherapeutic agent (melphalan hydrochloride), using national and local safety guidelines. The pharmacist should be aware of the rapid preparation time required for the preparation and administration of melphalan for use with the CHEMOSAT® Hepatic Delivery System.
- DD** A qualified chemotherapy healthcare professional certified by the site to deliver chemotherapy, such as Interventional Radiology Technician or Registered Nurse.
- IN** A qualified intensivist, or appropriately qualified critical care specialist, responsible for providing medical management of the patient in the immediate post-procedure period during which the patient is in the intensive care unit or step down unit.

The procedure team is required to complete the Delcath training program. Refer to Procedure Flowchart on page 27 which provides an overview of the procedure and how the procedure team and their tasks work together.

To facilitate use of these instructions, the procedural sections include Healthcare User Identifiers to assist each user in identifying procedural steps applicable to them.

APPROXIMATE PROCEDURE TIMES

Approximate Total time = 2hrs – 2.5hrs

The typical duration of the procedure is the following:

Set-up and preparation of patient = 45-60 minutes

Drug infusion = 30 minutes

Washout = 30 minutes

Removal of catheters = 15-30 minutes

Please Note: There is some variability in the duration of time for these steps due to the experience and skill set of the user, procedural room conditions and patient's medical and anatomical status. A new user will take longer for these steps whereas an experienced user will take less time.

PROCEDURE

PREPARATION: PRIOR TO TREATMENT

O	IR	PF	AN	PH	DD	IN
---	----	----	----	----	----	----

All medications and supportive measures must be determined and administered in accordance with each institution's policies, guidelines, procedures, the CHEMOSAT® Hepatic Delivery System Instructions for Use and chemotherapeutic agent (melphalan hydrochloride) prescribing information.

Hepatic Vascular Mapping - Angiography and Embolization

In order to avoid inadvertent infusion of the gastrointestinal or visceral branches, conduct a thorough search for any variant anatomy. In addition, embolization of certain branches supplying the gastro-intestinal tract may be necessary.

- Prior to performing the procedure using the CHEMOSAT® Hepatic Delivery System, complete a visceral angiogram (celiac artery and superior mesenteric artery). The presence of a replaced or accessory hepatic artery should be specifically addressed. Evaluate the portal vein for patency with late imaging during celiac and superior mesenteric arteriography. Completely examine the arterial supply to the liver and assess and understand its impact on chemotherapy infusion. Use of a selective micro-catheter may be beneficial for both embolization and subsequent drug infusion.
- Angiographic mapping of the hepatic arterial circulation with embolization of gastrointestinal branches arising from hepatic arteries is required to avoid inadvertent infusion of the chemotherapeutic agent into gastrointestinal arterial branches. It is recommended to complete embolization at least one week prior to treatment to allow the arterial puncture site to heal. Embolization on the same day as procedure is discouraged since the intense anti-coagulation required for percutaneous hepatic perfusion may not allow stable thrombotic occlusion of the coil-embolized vessels.
- Assess liver blood supply and formulate a strategy for catheter placement to ensure adequate drug infusion to the entire liver. Dependent on vascular anatomy, this may require repositioning of the catheter during the procedure.
- Embolization of the gastroduodenal artery is frequently necessary, but depends on its origin relative to the branches of the distal proper hepatic artery. If the infusion catheter tip can be placed sufficiently distally to avoid retrograde reflux into the gastroduodenal artery, then the latter may not need to be embolized.

- For patients with supply of the left lobe of the liver from the left gastric artery, selective embolization of left gastric artery branches will be necessary.
- The origin of the right gastric artery and/or supra-duodenal branches, and need for their embolization, must be assessed individually.
- In some patients (~15%), the liver receives arterial blood supply from two (2) different arteries: the right lobe from the superior mesenteric artery (replaced right hepatic artery) and the left lobe of the liver from the celiac artery.
For such patients, the delivery of chemotherapeutic agent to the entire liver may be accomplished by either:
 - o Temporary balloon occlusion (or permanent coil embolization) of one artery while infusing the remaining patent hepatic artery. Potential risks of this method are ischemia and/or delayed re-perfusion of the occluded lobe. Infusion and filtration periods remain unchanged.
 - o Sequential volume-adjusted infusion of each branch (60% to right; 40% to left). Infusion times will be different for each lobe, but total infusion and filtration times remain unchanged.
- If the risk assessment is unfavorable or the anatomic variation is too complex to allow selective catheterization for safe delivery of chemotherapy, the procedure must not be performed.
- During the infusion procedure described below, a single optimal angiographic projection of the hepatic artery should be used to periodically document hepatic arterial patency and flow.
- Review computed tomography or magnetic resonance imaging to assess venous anatomy. Select the balloon spacing based on patient anatomy.

Coagulation Studies

- Perform coagulation studies pre-, peri- and post-procedure then repeat daily until normalized. Parameters tested must include:
 - Partial Thromboplastin Time
 - Prothrombin Time / International Normalized Ratio

Blood Products

Type and cross-match for:

- 4 units packed red blood cells
- 4 units Fresh Frozen Plasma
- 6–10 units platelets (depending on institutional guidelines)
- 10 units cryoprecipitate

Hydration

- Place a peripheral large gauge intravenous catheter and begin hydration the night prior to or day of the procedure as per institutional practice, to assist with maintaining mean arterial pressure above 60 mmHg during the procedure.
- A Foley catheter is recommended to closely monitor fluid balance during hydration.

Antibiotics

- Patients with a history of hepatobiliary surgery or ablative procedures must receive antibiotic prophylaxis peri-operatively.

Allopurinol

- As a prophylaxis for possible tumour lysis syndrome, patients with more than 25% replacement of normal liver parenchyma with tumour are to be given allopurinol 300 mg/day orally beginning two (2) to three (3) days prior to percutaneous hepatic perfusion (PHP) with the CHEMOSAT® Hepatic Delivery System and continuing two (2) to three (3) days following procedure.

Proton Pump Inhibitors

- To prevent gastritis which may occur as a result of regional melphalan absorption during the procedure, administer prophylactic proton pump inhibitors (for example: omeprazole, one 20 mg delayed release capsule by mouth no later than 8 PM the night before and at 7:30 AM the morning of the procedure followed by pantoprazole 40 mg intravenous every 8 hours during hospitalization).

Anticoagulation

- The patient will be systemically anticoagulated with heparin during the procedure. Proper anticoagulation is required to assure free extracorporeal flow and filtration. Activated clotting time must be closely monitored to ensure adequate anticoagulation.
 - Obtain the baseline activated clotting time value.
 - Administer heparin to the patient only AFTER placement of the 18F (femoral vein), 10F (jugular vein), and 5F (femoral artery) sheaths. Use Ultrasound guidance and single anterior wall puncture technique during sheath placement in order to avoid bleeding complications.
 - The patient must be fully heparinized prior to the insertion of the Isofuse® Catheter into the inferior vena cava. Begin with an initial intravenous bolus of heparin at 300 units/kg, dose adjusted to achieve activated clotting time.
 - A minimum activated clotting time of 400 seconds is necessary prior to balloon inflation and initiation of veno-venous bypass.
 - Maintain the activated clotting time above 400 seconds by repeat heparin bolus administration as necessary.
 - Evaluate activated clotting time frequently (approximately every 5 minutes) until adequate anti-coagulation is established (activated clotting time > 400 seconds). Maintain activated clotting time at > 400 seconds throughout the procedure, by checking it every 15 – 30 minutes depending on the patient's response and by administering intravenous heparin as needed.

Anesthetic Management

- Treatment must be administered with patients being monitored and under general anesthesia. Emergency resuscitation equipment must be available during the procedure.

Blood Pressure Control

- Procedure related decrease of blood pressure occurs when the balloons occlude blood return from the inferior vena cava (decreased cardiac inflow) and when the filters are brought into the extracorporeal bypass circuit. The reasons for filter-related hypotension are multifactorial, but hypersensitivity to non-physiological surfaces (inflammatory response) and removal of catecholamines by the filters play a role. To aid blood pressure maintenance for extracorporeal bypass, the following actions are recommended per institutional practice:
 - Pre-operative hydration and intra-procedural administration of fluids.
 - Vasopressor use in accordance with institutional practices.
 - Administration of steroids prior to initiating extracorporeal bypass, in accordance with institutional practice.
- Blood pressure must be constantly monitored throughout the procedure and maintained at levels required for adequate perfusion of critical end-organs.

Drug Preparation and Delivery Planning

Prior to set up, provide pre-notification to the hospital pharmacy to be ready to prepare chemotherapeutic agent (Melphalan Hydrochloride for Injection). An actual request for drug preparation and delivery should be timed so that the start of the infusion of the melphalan is within thirty minutes of preparation. Drug administration should be completed within 60 minutes of the start of preparation.

System Components

Confirm that all components of the CHEMOSAT® Hepatic Delivery System are available for assembly. Note: Certain components are not supplied by Delcath. Verify that the Medtronic pump is functioning properly (see pump operating manual for instructions on proper functionality).

PREPARING AND PRIMING THE HEMOFILTRATION CIRCUIT

PF

CAUTION: Adherence to strict sterile procedures is mandatory at all times.

1. Assemble Hemofiltration Circuit

See Figure 1 (Assembled System) for reference to a completely assembled circuit.

- (a) Utilizing strict aseptic technique, heparinize nine (9) liters of 0.9% Sodium Chloride Injection (normal saline) by adding 2000 units of heparin per liter.
- (b) Remove Hemofiltration (Chemofiltration) Dual Filter Cartridge from sterile pouch. Attach the filter to the intravenous pole using the built-in pole mount clamp, see Figure 3. Refer to "THIS END UP" label on filter faceplate, see Figure 4.



Figure 3

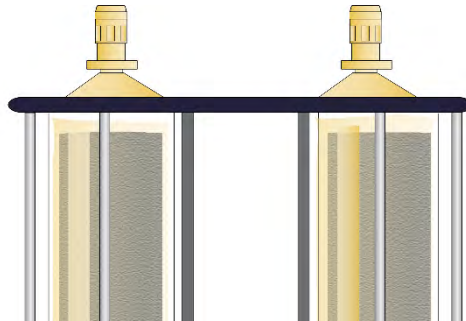
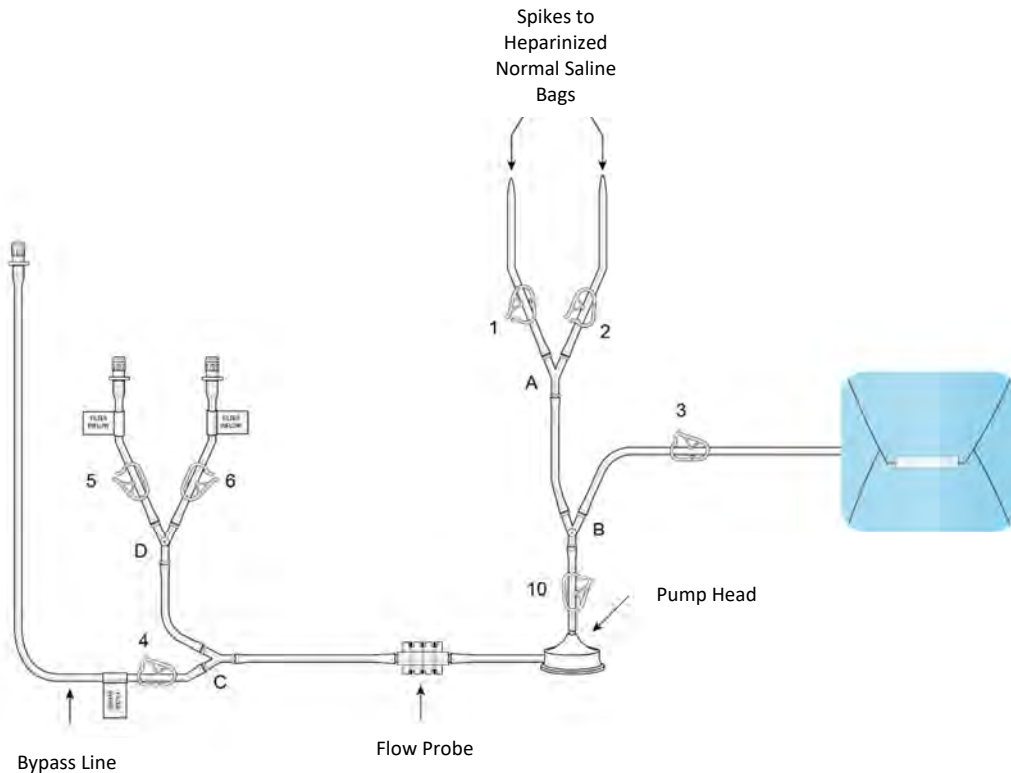

Figure 4

- (c) Open the circuit tray and remove the components that are in the pouches, and set aside for later assembly.
- (d) Remove the "Filter Inflow Assembly" section from the circuit tray, place pump head on the pump drive motor, and insert flow probe into flow transducer, see Figure 5.



Filter Inflow Assembly – Figure 5

- (e) Connect the Inflow lines (labeled and identified as in Figure 6) to the cartridge inlet connectors located on the bottom of the dual filter. To complete the assembly, push the quick connector couplings together, as shown in Figure 6 (male to female) until an audible “click” is heard to verify connection (push and click).

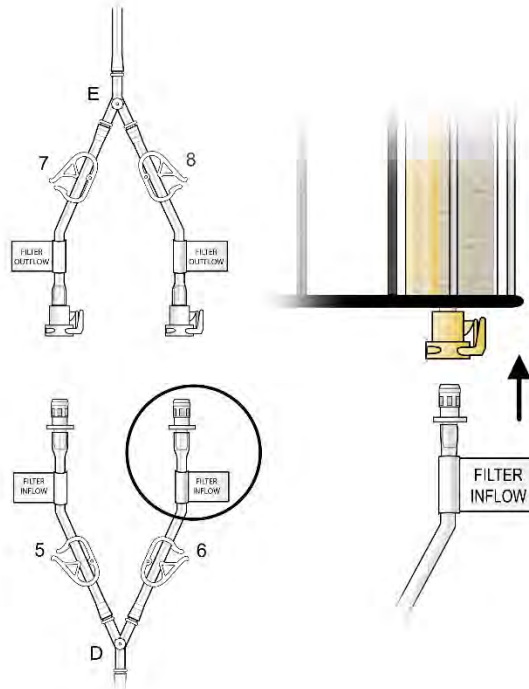
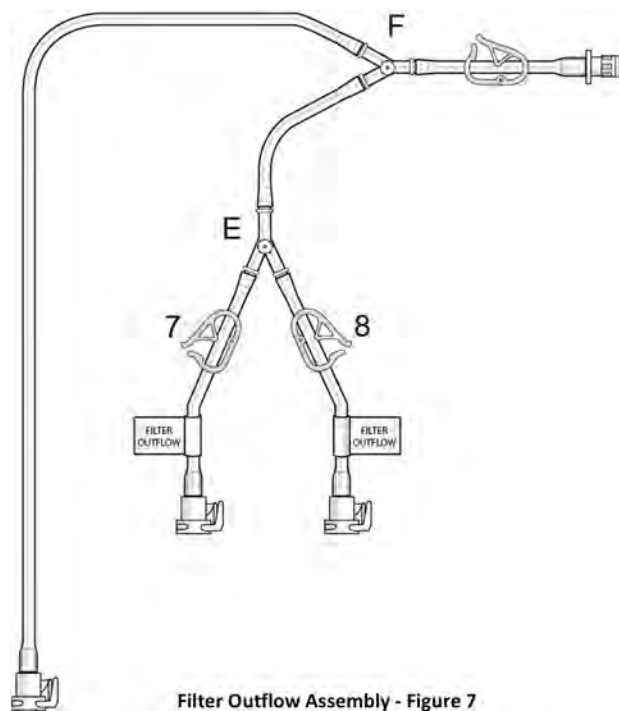

Figure 6

- (f) Remove the “Filter Outflow Assembly” section from its sterile pouch, see Figure 7.



- (g) Connect the outflow lines (labeled and identified as in Figure 8) to the filter cartridge outlet connectors located on the top of the dual filter using the quick connector couplings (push and click), see Figure 8.

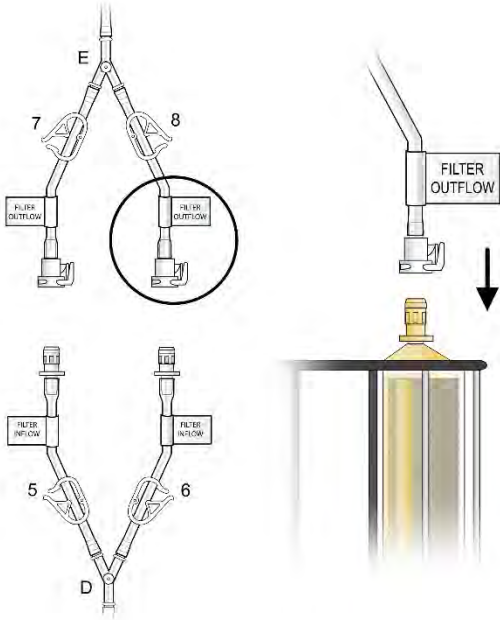

Figure 8

- (h) Assemble the two ends of the bypass line by pushing the quick connectors together (push and click), see Figure 9.

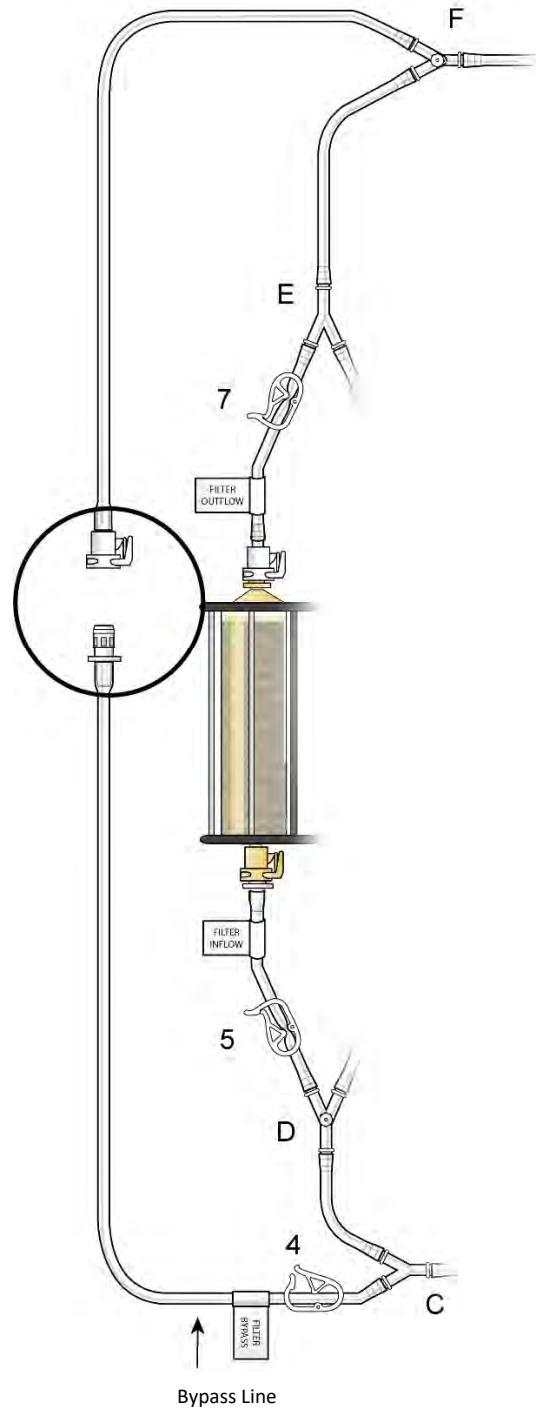

Figure 9

- (i) Remove the "Prime/Flush Line" from its sterile pouch and attach it to the quick connect coupling located proximal to Y-connector "F", as shown in Figure 10. Place the open end of the "Prime/Flush Line" into the basin for collecting the flushed effluent during filter hydration.

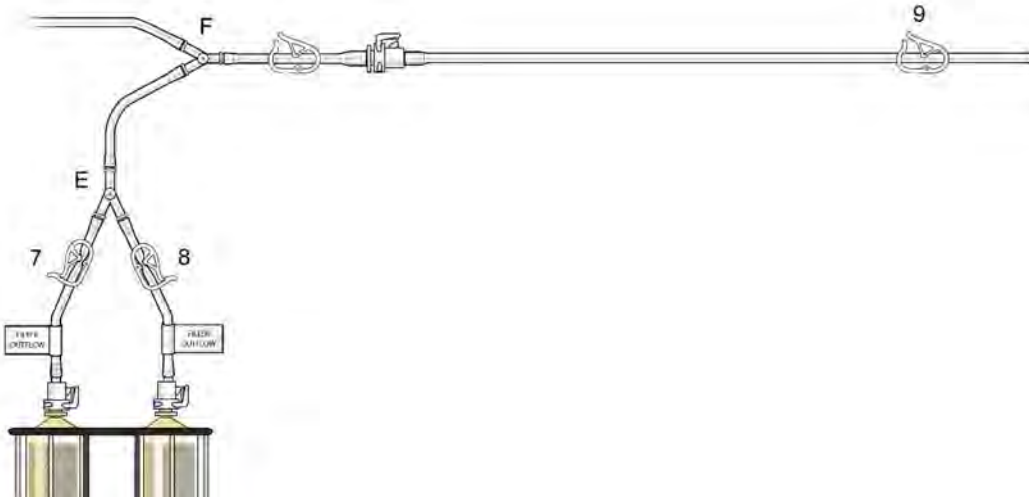

Figure 10

- (j) Attach the supplied stopcocks to the "B" (pre-pump), "D" (pre-filter) and "F" (outlet) Y-connector ports. Verify "Bypass Line" clamp 4 is open, as shown in Figure 11.

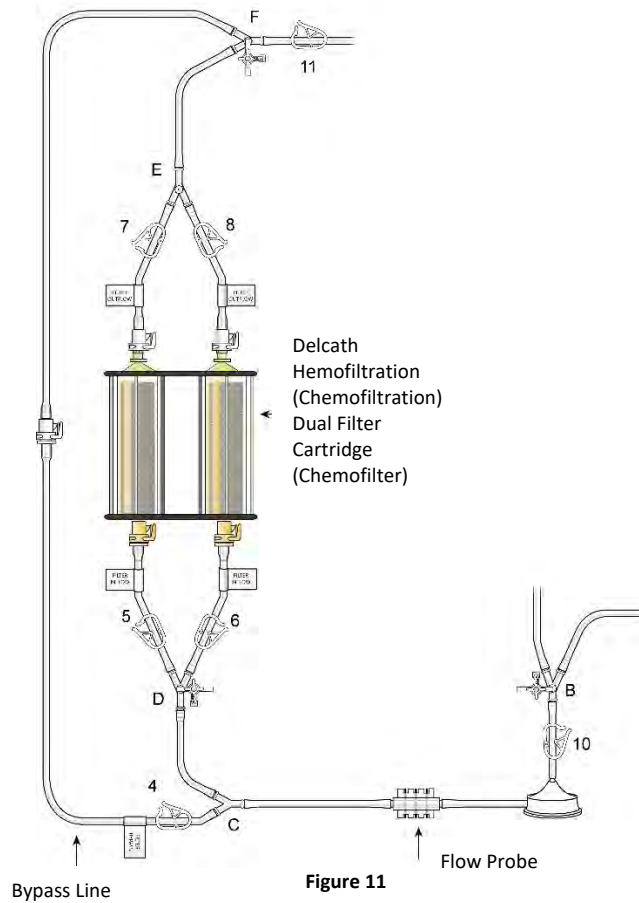

Figure 11

(k) System CO₂ Prime:

- Close outlet clamp (11), attach the CO₂ connection line to the stopcock "F", and open the stopcock, see Figure 12.

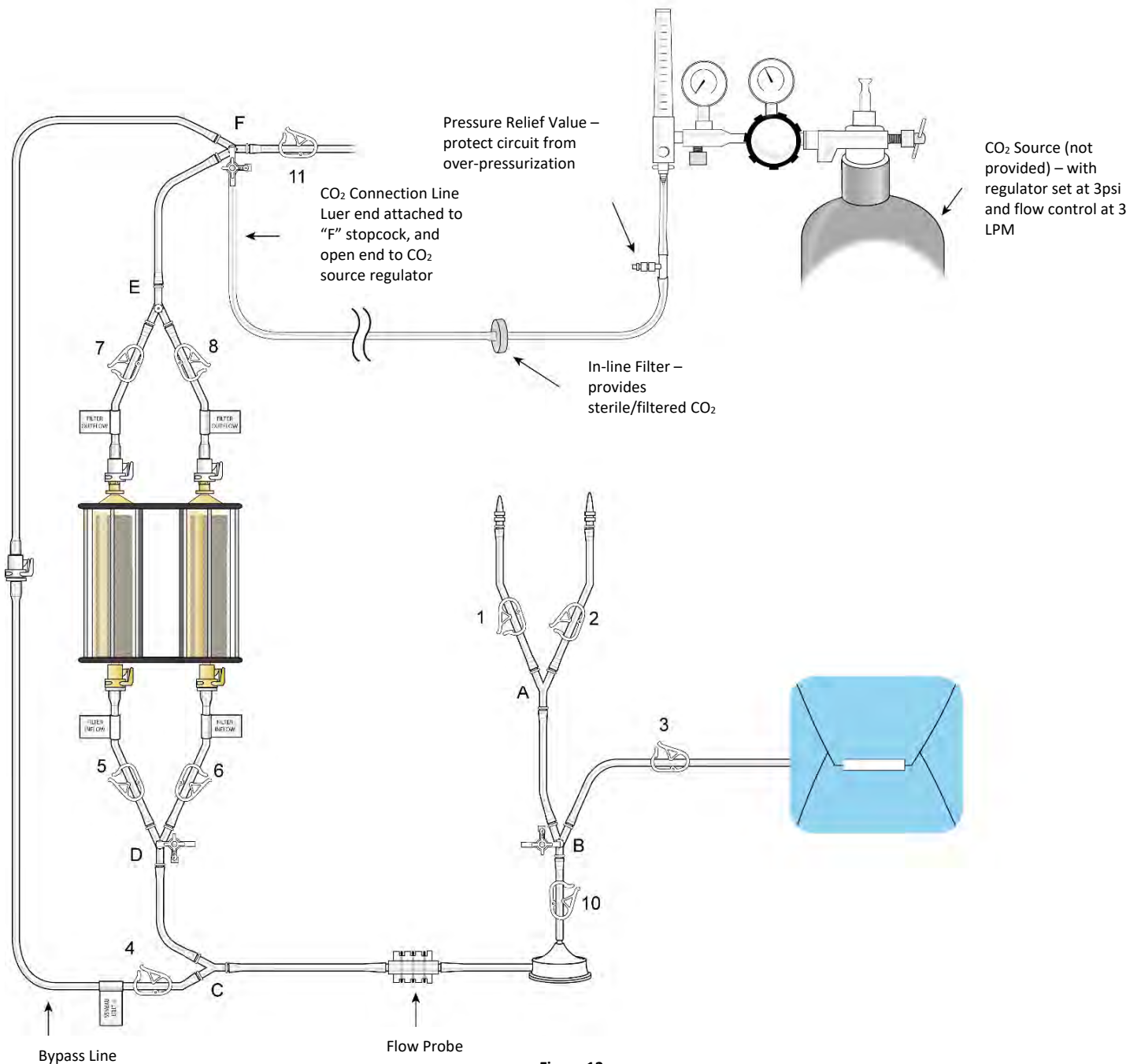

Figure 12

- Connect the open end of the CO₂ connection line to the CO₂ source, and set the CO₂ source regulator to 3psi (approximately 3.0 liters per minute (LPM)).
- Start the CO₂ gas flow and allow the CO₂ to flow through the hemofiltration circuit. Adjust CO₂ regulator to maintain 3psi (as necessary). Verify CO₂ flow through the circuit.
- Close bypass clamp (4) after approximately 1 minute to ensure flow through the hemofiltration cartridges. Allow CO₂ to flow through the cartridges (after closing clamp 4) for at least 5 minutes.
- Close saline clamps (1, 2), double balloon catheter line clamp (3), filter inlet clamps (5, 6), and then filter outlet clamps (7, 8) to lock CO₂ within the circuit. Stop the CO₂ flow, and close the stopcock "F" and disconnect the CO₂ connection line and discard.

CAUTION: Use strict aseptic technique while spiking the heparinized normal saline bags.

- (l) Hang two bags of the heparinized sterile normal saline and connect to circuit by using the spikes, as shown in Figure 13, to allow for gravity priming of circuit components.

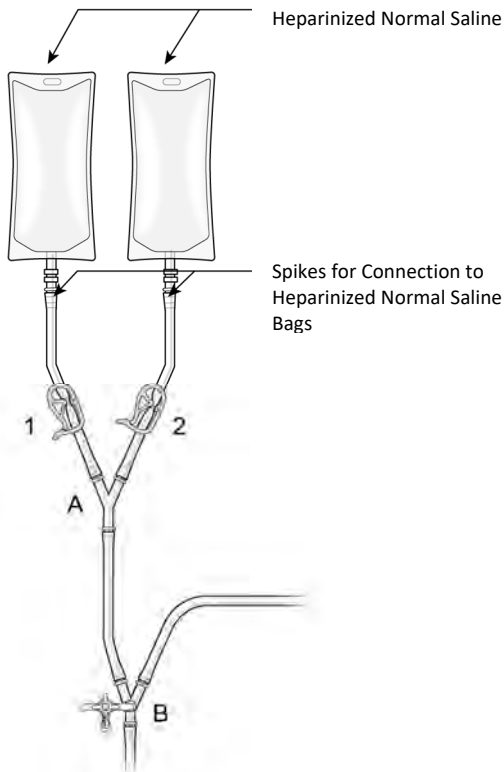

Figure 13

2. Prime Delcath Isofuse® Isolation Aspiration Catheter

- (a) Close pre-pump clamp (10), open double balloon catheter line clamp (3), open saline line (clamp 1 or 2), and stopcock "B" to allow heparinized normal saline to prime line only up to clamp 3, see Figure 14. Once the stopcock line is primed and the double balloon catheter line is primed up to clamp 3, close clamp 3 and stopcock. **Do not allow excess heparinized normal saline to fill sterile wrap.**

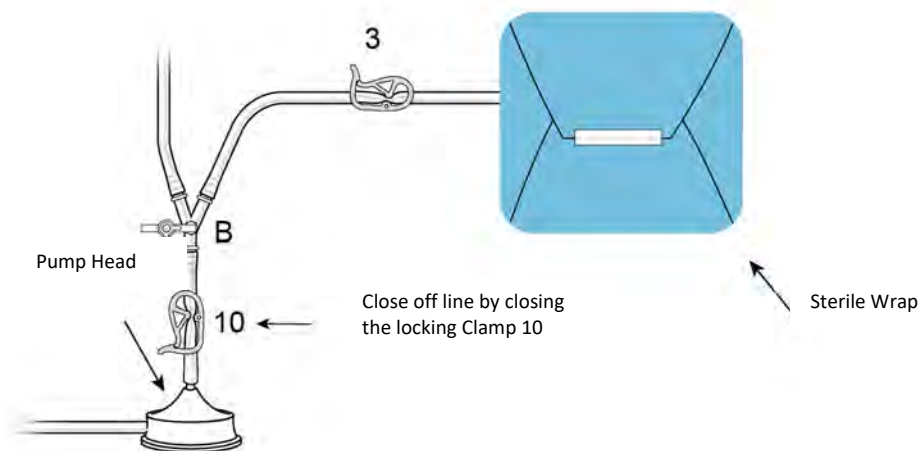

Figure 14

3. Prime Bypass Line

(a) Prime the pump head, filter inflow and bypass lines by opening clamp 10, stopcock "D", and clamp 4, see Figure 15.

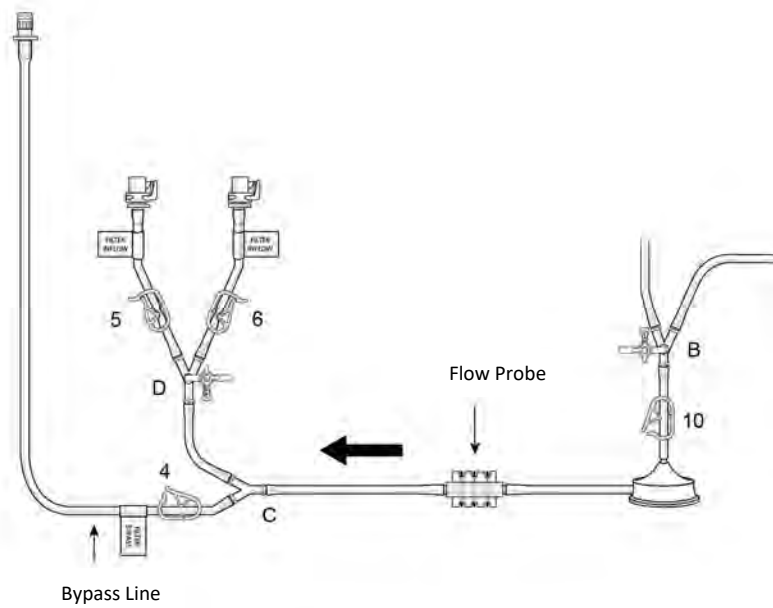

Figure 15

4. Prime and Flush Delcath Hemofiltration (Chemofiltration) Dual Filter Cartridge (Chemofilter)

CAUTION: Do NOT allow heparinized normal saline bags to run dry or air will enter the system.

(a) Close clamp 4 and open filter inlet clamps (5, 6) then filter outlet clamps (7, 8) and circuit outlet clamp (11) (see Figure 16) and adjust the flow of heparinized normal saline into the filter to a rate of approx. 0.5 liters per minute. Note: Hemostats (forceps) are required to adjust flow rate if using gravity.

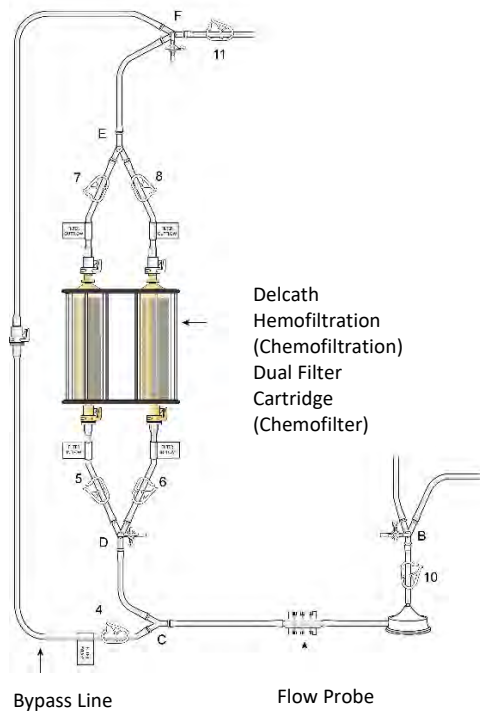

Figure 16

CAUTION: Do not use excessive force when tapping the plastic housing.

- (b) Allow heparinized normal saline to flow out through the filters and out the "Prime/Flush Line" for approximately six (6) minutes or until the filter appears gas free (solid black). Once all gas appears to have been displaced, tap gently to encourage any trapped gas bubbles to rise, turn cartridge within housing to visualize and access entire filter. Only tap on the sides of the cartridge (Do not tap on the end caps or quick connector couplings).
- (c) When Filter Cartridges are gas free, flush with an additional six (6) liters of heparinized normal saline (3 L/cartridge).
- (d) Clamp all filter lines (5, 6, 7, 8) and outlet clamp 11.

5. Prime Venous Return Line and Bubble Trap

CAUTION: Do NOT install the Return Line with built-in Bubble Trap until flushing is complete.

- (a) Disconnect and dispose of the "Prime/Flush Line", by pressing in the latch located on the female quick connect coupling and pulling it a part.
- (b) Open the Venous Return sterile pouch and remove the venous return line and built-in bubble trap, (Figure 17).

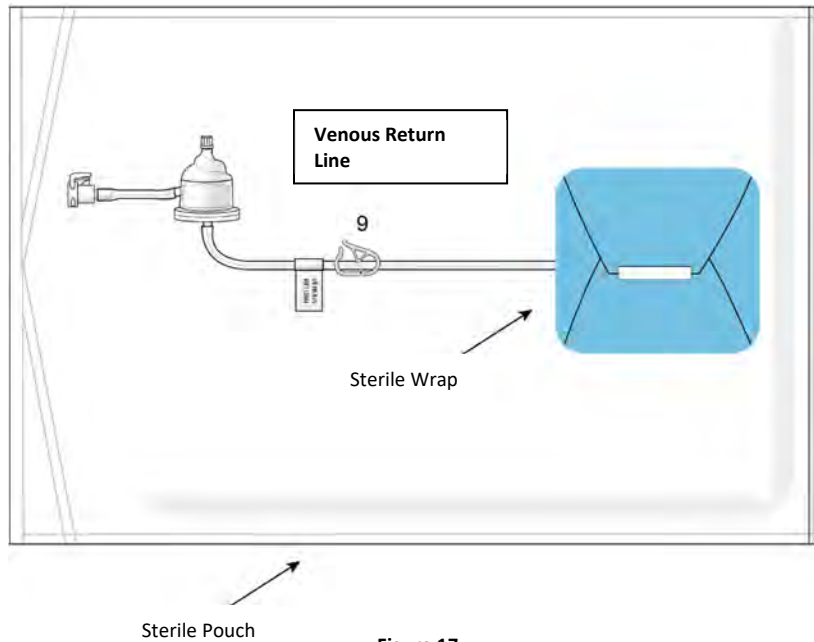

Figure 17

- (c) Attach the female to the male quick connector (push and click) located by outlet clamp (11), as shown in Figure 18. Position the bubble trap in the bubble trap holder higher than filter cartridges.

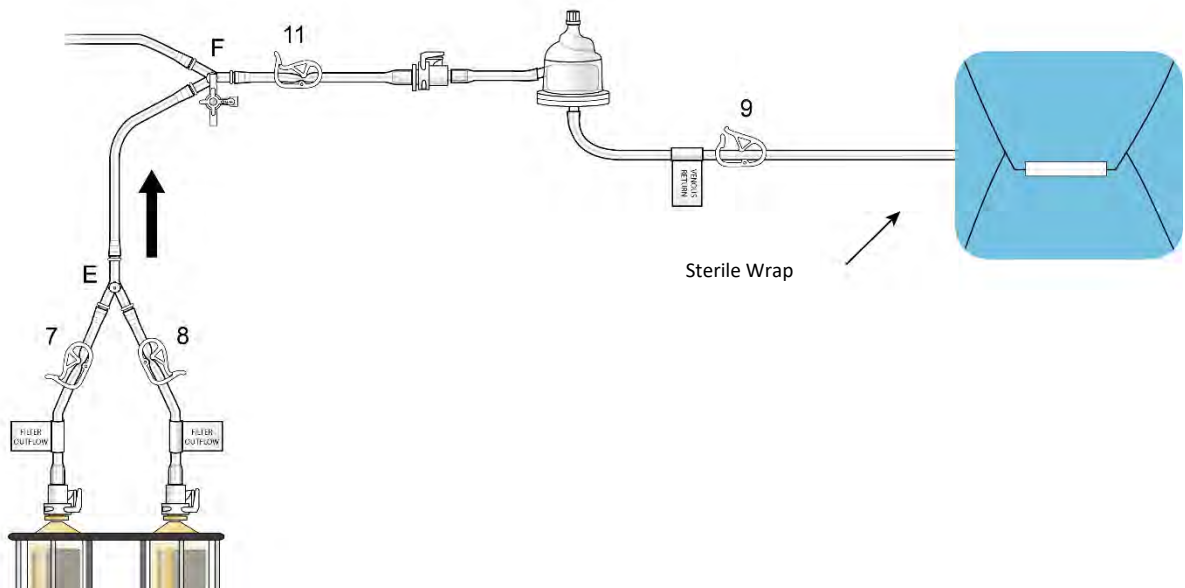

Figure 18

WARNING

Ensure That All Air is Purged From The System Prior To Use In Order To Avoid An Air Embolism

- (d) Prime venous return line and bubble trap by opening clamps 4, 11 and 9; attach stopcock to bubble trap and use syringe to aspirate air, as necessary, see Figure 19.

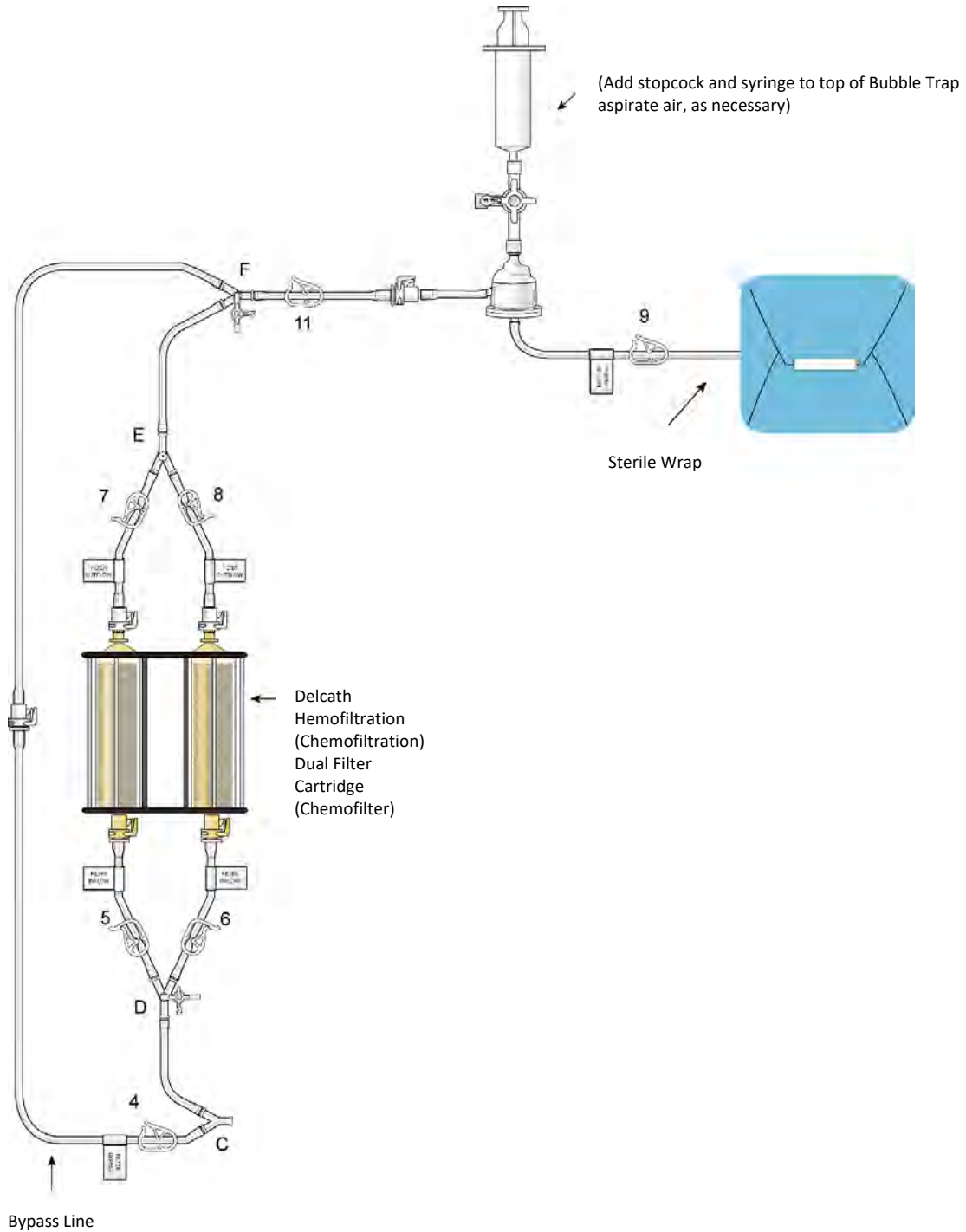

Figure 19

- (e) Close clamp 9 once venous return line and bubble trap are primed up to clamp 9.

6. Install Pressure Monitoring Lines

- (a) Attach pre-pump (to measure negative pressure – pump suction) pressure monitoring line to stopcock “B” and prime, see Figure 20.

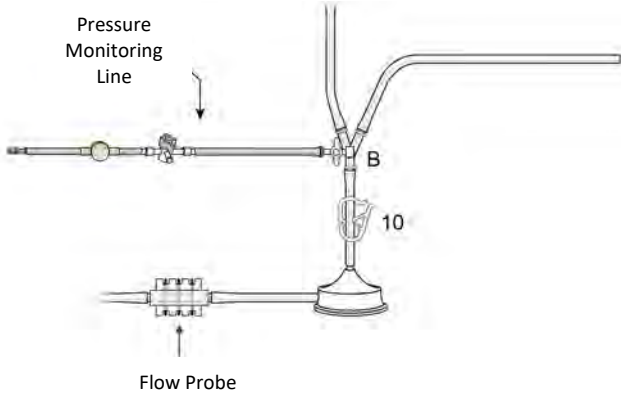

Figure 20

- (b) Attach pre-filter (to measure positive pressure – pre-filter) pressure monitoring line to stopcock “D” and prime, see Figure 21.

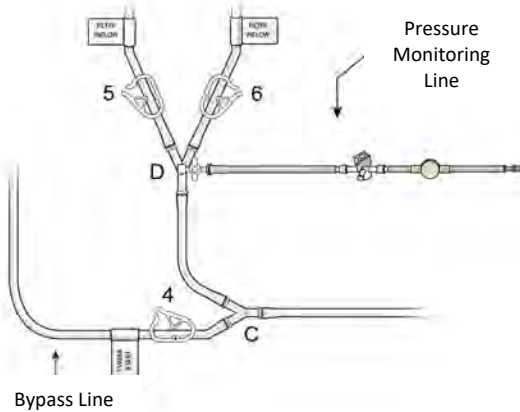

Figure 21

- (c) Attach the pressure monitoring lines to the P1 and P2 ports on the rear of the Medtronic Bio-Console 560 Speed Controller System.
 (d) Zero the pressure transducers (refer to Medtronic Bio-Console 560 System Manual for details).
 (e) Coiled pressure monitoring lines are included for use with DLP Pressure Display Boxes, as necessary.

7. Pressure Test Circuit

- (a) Pressure test circuit by slowly ramping up the pump head speed (RPM) until a pressure reading of 300 mmHg is achieved on the pressure transducer attached to the line on Y-connector “D” (pre-filter).
 (b) Visually inspect all connections and cartridges to ensure no leaks are present.

CAUTION: If leak is noted, ensure connections are secure before proceeding.

- (c) Turn off pump and close cartridge inlet (5, 6) and outlet (7, 8) clamps. Ensure bypass line clamp (4) is open.
 (d) System is now primed, hydrated, de-bubbled, and ready for use.
 (e) Ensure there are two (2) liters of normal saline available for later use.

PLACING THE CATHETERS



8. Insertion of the 10F Venous Return Sheath

- (a) Attach the stopcock to the sheath side port tube. Using standard Seldinger technique (with ultrasound guidance), insert the venous return sheath, into the internal jugular vein (preferably the right side internal jugular vein, see Figure 22). Flush the sheath with sterile heparinized normal saline. Close the stopcock. Use of sonographic guidance and a single anterior wall puncture of the vein are required to avoid inadvertent carotid artery puncture. If a carotid artery puncture is inadvertently made, the procedure must be aborted and postponed to a later date. Insert the obturator through the valve post placement of the sheath.

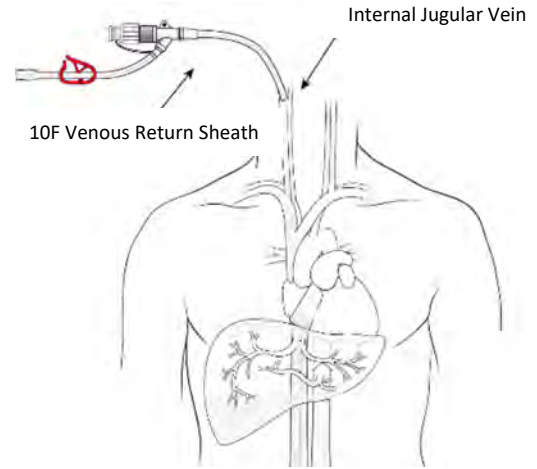

Figure 22

9. Insertion of the 5F Femoral Arterial Sheath

- (a) Using Seldinger puncture technique and standard fluoroscopic and arteriographic techniques, place the 5F Introducer Sheath into the femoral artery, see Figure 23. Use of sonographic guidance and a single anterior wall puncture of the femoral artery over the femoral head are required so as to assure compressibility of the artery when the sheath is removed. If a supra-inguinal puncture is inadvertently made, the procedure must be aborted and postponed to a later date.

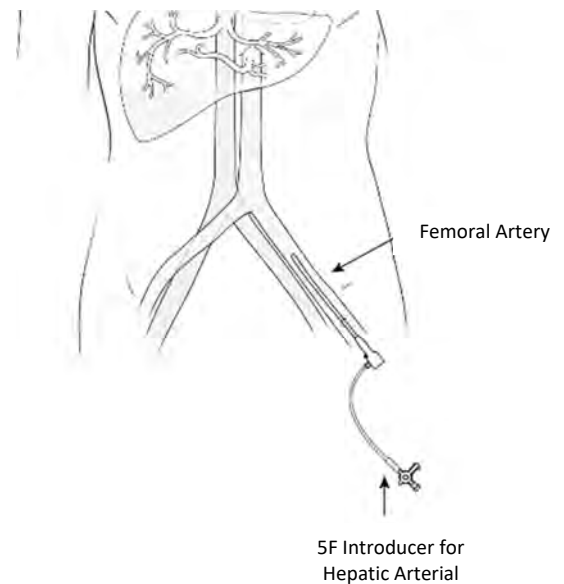

Figure 23

10. Insertion of the 18F Venous Sheath

- (a) Using Seldinger technique and standard fluoroscopic and angiographic techniques, place the 18F introducer sheath into the femoral vein after serial dilation with 9F and 13F dilators. The venous sheath may be placed ipsilateral or contralateral to the 5F femoral arterial sheath placement, see Figure 24. Flush the sheath with sterile heparinized normal saline. Use of sonographic guidance and a single anterior wall puncture of the femoral vein over the femoral head are required so as to assure compressibility of the vein when the sheath is removed. If a supra-inguinal puncture is inadvertently made, the procedure must be aborted and postponed to a later date.

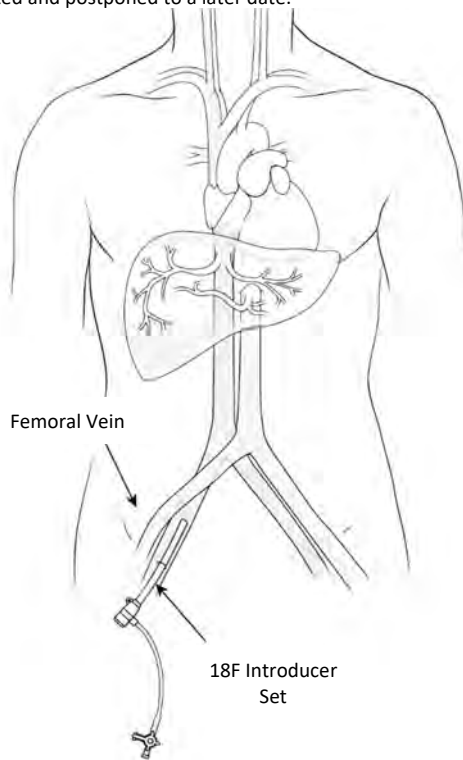

Figure 24

11. Insertion of 5F Chemofuse® Infusion Catheter

- (a) Introduce the 5F Chemofuse® catheter through the sheath and manipulate it over a guidewire into the proper hepatic artery, see Figure 25. At the discretion of the Interventional Radiologist, a microcatheter may be coaxially introduced through the 5F catheter for selective catheter tip placement for drug infusion. If a microcatheter is used, attach a rotating hemostatic valve (Touhy-Borst type) to the 5F catheter and insert the microcatheter into the 5F catheter through the valve. Three microcatheters have been qualified by Delcath for use with the CHEMOSAT® Hepatic Delivery System. Select one of the three microcatheters qualified (see Description of System Components (pg. 6)).

- (c) Connect the infusion catheter (5F catheter or microcatheter) to the drug delivery system (see step 18), and maintain catheter patency by hospital catheter infusion protocols (e.g., infuse heparinized normal saline: The concentration of heparin should be 1000 units per 500 mL of normal saline.)

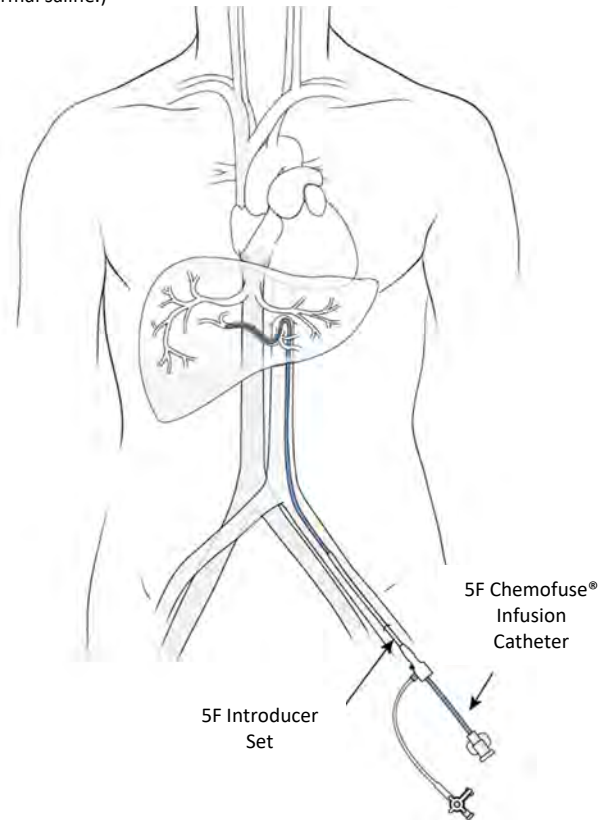

Figure 25

ESTABLISHING ANTICOAGULATION & PLACING ISOFUSE® ISOLATION ASPIRATION CATHETER

IR	PF	DD
----	----	----

12. Anticoagulation

- (a) Obtain the baseline activated clotting time value.
- (b) Administer Heparin AFTER percutaneous placement of all introduction sheaths is completed, BUT PRIOR to the insertion of the Isofuse® Isolation Aspiration catheter into the inferior vena cava.
- (c) Administer an initial intravenous bolus of 300 units/kg of heparin. Heparin dose should be adjusted to achieve a minimum activated clotting time of 400 seconds prior to initiation of veno-venous bypass and balloon inflation.
- (d) Evaluate activated clotting time frequently (approximately every 5 minutes) until adequate anti-coagulation is established (activated clotting time > 400 seconds). Maintain activated clotting time at > 400 seconds throughout the procedure, by checking it every 15-30 minutes depending on the patient's response, and administering intravenous heparin as needed.

WARNING

The Catheter Must Be Positioned As Described Below So That Drug Is Infused ONLY Into The Liver. Perfusion Of Drug Into Any Other Abdominal Organ Or Gastrointestinal Branches Must Be Avoided As This May Result In Serious Injury Or Death.

- (b) Position the infusion catheter (5F catheter or microcatheter) in the proper hepatic artery well beyond the origin of the gastroduodenal artery to deliver chemotherapeutic agent (melphalan hydrochloride). Affix the 5F catheter to the skin at the groin.

WARNING

The Start Of The Intra-Arterial Infusion Of The Drug Solution Must Be Within 30 Minutes Of Its Preparation In The Pharmacy.

NOTE: TIMING OF CHEMOTHERAPEUTIC AGENT DELIVERY

Time the request for delivery of the chemotherapeutic agent (Melphalan Hydrochloride) so that the start of the intra-arterial infusion of the drug solution is within thirty minutes of its preparation. Since preparation and delivery times vary, depending upon local practices, the timing of the request is critical and should be pre-arranged with the pharmacist. Typically, the time to request chemotherapeutic agent from the pharmacy would be when the Isofuse® Isolation Catheter is being positioned in the inferior vena cava.

13. Insertion of the Isofuse® Isolation Aspiration Catheter

- (a) Flush the Isofuse® catheter with heparinized normal saline.
- (b) Introduce the Isofuse® catheter through the 18F sheath. Under fluoroscopic guidance advance it over a guidewire into the inferior vena cava and position the catheter tip at the level of diaphragmatic hiatus. Do NOT inflate balloons.
- (c) Upon successful placement, remove guidewire and create a heparin lock within the “OTW” lumen to maintain patency.

CONNECTING CATHETERS TO HEMOFILTRATION CIRCUIT



14. Connection of Catheter to Hemofiltration (Chemofiltration) Circuit

- (a) Remove sterile wrap from hemofiltration circuit double balloon catheter line while maintaining sterility, and transfer sterile end to interventional radiologist.
- (b) Open saline line (clamp 1 or 2) clamp and clamp 3 to allow for a “wet connection” of the hemofiltration circuit to the Isofuse® catheter. After connection is made, close saline line clamp (clamp1 or 2). Ensure that all air is removed from the Isofuse® catheter.
- (c) Remove the sterile wrap from the hemofiltration circuit venous return line while maintaining sterility, and transfer sterile end to the interventional radiologist and flush normal saline to fill the line.
- (d) Connect the hemofiltration circuit venous return line to the stopcock of the 10F venous return sheath placed in the jugular vein (Venous Return Sheath tubing has a red clamp), flush normal saline through the line. When all air is removed and line is completely filled with normal saline turn stopcock to close the side port. Ensure the stopcock (at the venous return line to sheath connection) is fully open to minimize back pressure and maximize flow through the stopcock. (“OFF” handle of stopcock turned 90° to flow path.)

15. Establishing Hemofiltration Circulation

- (a) Start pump and slowly increase RPM control to achieve a maximum allowable flow rate which does not cause flow induced vibration or exceed the 0.80 L/min flow rate or -250 mmHg pre-pump pressure.
 - Flow rates of approximately 0.40 to 0.75 liters/minute are typical; however, **0.80 L/min** is the maximum allowable flow rate for this system.
 - In-line pressure transducers should be used to monitor pressures:
 - Pre pump pressure (suction side) should not be more negative than **-250 mmHg**, as lower pressures indicate possible catheter collapse or kink.
 - Pre-cartridge pressures (pre-filter) should not exceed **200 mmHg**, as higher pressures indicate increasing filter resistance potentially due to thrombus or a kinked return line. Check filters to assure free flow and return line for kinks.
- (b) The hemofiltration circuit is now established. Venous blood is aspirated from the central lumen through the fenestrations in the Isofuse® catheter. This blood flows through the Isofuse® catheter to the pump, through the bypass line, and returns to the patient through the venous return sheath.

CAUTION: Continuously monitor any perfusion related events including:

- Blood flow-rate as displayed by the Medtronic Bio-Console 560 System.
- Systolic, diastolic and mean arterial blood pressure.
- Heart rate and vital signs.
- Activated clotting times.
- Bubble-trap for entrapped air.
- Leaks from any part of the circuit.

ISOLATING THE INFERIOR VENA CAVA



16. Inflation of Balloons

WARNING

There Is An Anticipated Significant Decrease Of Blood Pressure Following The Initial Occlusion Of The Inferior Vena Cava By The Balloons. It Is Critical To Maintain Mean Blood Pressure Above 65 mmHg

Vasoactive Agents Response Testing: Prior to inflation of either balloon (occlusion of inferior vena cava), administer vasoactive agent to assess patient responsiveness to this agent. After inflation of the balloons, assess patient blood pressure for two (2) to five (5) minutes before proceeding. Significant decreases in blood pressure will occur within two (2) to five (5) minutes.

Continue to administer vasoactive agents to maintain mean blood pressures above 65 mmHg. Vasopressor agents are typically not required after the conclusion of the procedure.

- (a) Perfusionist must carefully monitor the flow rate during the balloon inflation.

WARNING

Do NOT Overinflate The Balloons. Overinflation Of The Balloons Could Cause The Balloons To Burst Which Could Result in Life-Threatening Injury.

- (b) Maximum balloon inflation volumes:
 - Cephalad Balloon: **38 mL** of dilute contrast medium
 - Caudal Balloon: **38 mL** of dilute contrast medium
- (c) Under fluoroscopy, partially inflate the cephalad balloon with approximately 15- 25 mL of dilute contrast media (e.g., 35% dilution) within the right atrium (the balloon will have a rounded appearance).
- (d) With the caudal balloon still deflated, slowly retract the Isofuse® catheter until the cephalad balloon is at the junction of the right atrium and inferior vena cava. If needed, further inflate the cephalad balloon until indentation of the diaphragmatic hiatus is visible at the inferior margin (the balloon will acquire an acorn shaped appearance, see Figure 26). Do not inflate balloons beyond required volume to achieve an adequate seal. Never advance or retract the Isofuse® catheter when both balloons are inflated. If resistance is met during manipulation, determine the cause of the resistance before proceeding.



Figure 26

- (e) Under fluoroscopy, inflate the caudal balloon with dilute contrast medium until the lateral edges of the inflated balloon start to become effaced by the inferior vena cava wall.

WARNING

Never Stop Blood Flow Through The Hemofiltration Circuit For More Than 30 Seconds.

- (f) With balloons inflated, perform a limited (retro-hepatic) inferior vena cavagram (using digital subtraction angiography technique) through the fenestrations. Prior to injection of contrast medium, reduce the pump speed to 1000 RPM and clamp off the circuit. Inject iodinated contrast medium through the CONTRAST port to confirm that the catheter properly isolates hepatic venous flow between the balloons. The cephalad balloon must occlude the inferior vena cava just above the highest (closest to right atrium) hepatic vein, and the caudal balloon must occlude the inferior vena cava just below the lowest hepatic vein (above the renal veins) as shown in the radiographic image in Figure 27.



Figure 27

Re-establish flow through the hemofiltration circuit by unclamping the circuit and returning pump RPM to deliver previous flow rate.

WARNING

Never Adjust the Position of the Double Balloon Catheter Unless Both Balloons are Fully Deflated.

- (g) If the Isofuse® catheter is not in the proper position, deflate both balloons (caudal balloon first) and then reposition the catheter, while maintaining flow in the hemofiltration circuit.
- (h) Once satisfactory position is attained (i.e., the isolated segment is well sealed), gently hold the proximal end of the Isofuse® catheter to prevent upward migration of the catheter into the right atrium. The catheter must be held and its position checked for the duration of the procedure (approximately 60 minutes).

CAUTION: Check Isofuse® catheter balloon positions fluoroscopically every four (4) to five (5) minutes during drug administration and filtration to ensure continued hepatic venous isolation.

BRINGING HEMOFILTRATION CARTRIDGES ON

LINE PF AN

17. Bringing Hemofiltration Cartridges on Line

- (a) Continuously monitor and check the patient's blood pressure as required (see "Blood Pressure Control").

- (b) Leaving the bypass line open, open clamps on the left cartridge (5 and 7), and allow blood to displace the heparinized normal saline into the patient.
- (c) After the heparinized normal saline in the left cartridge and its lines is fully replaced with blood, wait approximately 30 seconds and open clamps on the right cartridge (clamps 6 and 8), while keeping the bypass line open. Once the heparinized normal saline in the right cartridge and its lines is fully replaced with blood, wait approximately 30 seconds and then close the bypass line by **securely closing clamp 4**. Add a reusable tube clamp as a redundant bypass closure mechanism high on the bypass line in clear view of the team.

WARNING

Close Bypass Line Prior To Infusion of Drug.

SETUP DRUG DELIVERY SYSTEM AND START EXTRACORPOREAL FILTRATION

IR DD

18. Drug Administration and Extracorporeal Filtration

- (a) When the hemofiltration circuit is running satisfactorily and the patient is hemodynamic stable, flush the hepatic arterial infusion line with normal saline to avoid directly mixing heparin with chemotherapeutic agent (melphalan hydrochloride). Connect drug infusion line to Hepatic Artery Infusion catheter (5F Chemofuse® Catheter or microcatheter), as shown in Figure 28 to complete the drug delivery circuit.
- (b) Following normalization of blood pressure, perform an arteriogram to assess patency of the hepatic artery. Use undiluted iodinated contrast agent to check for hepatic artery spasm via CT. The contrast is injected by hand via the syringe for the arteriogram. In circumstances where hepatic arterial spasm is noted, administer nitroglycerin intra-arterially to alleviate the spasm. Always flush the injection line with normal saline after contrast injections.

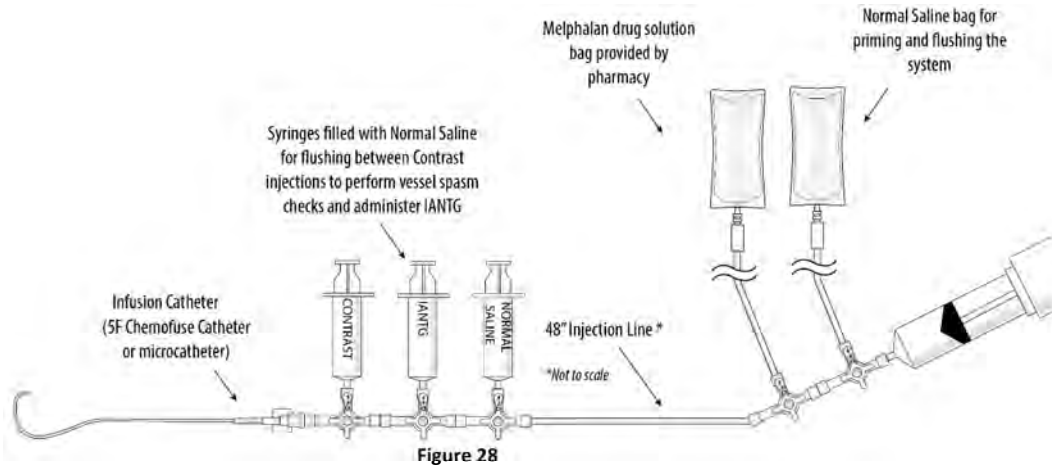

WARNING

Assess Arterial Patency Approximately Every Four (4) to Five (5) Minutes Via Contrast Administration During Drug Infusion. Administer Intra-Arterial Nitroglycerin if Arterial Spasm is Noted. If Spasm Cannot be Relieved, Terminate the Procedure (see Ending Extracorporeal Circulation below).

- (c) Initiate administration of the chemotherapeutic agent (melphalan hydrochloride) through the infusion catheter (5F Chemofuse® or microcatheter) over a period of 30 minutes.

WARNING

Immediately Stop The Procedure If Perfusion Of Drug Is Detected Outside Of The Isolated Region And Cannot Be Corrected. Once the Infusion Of Chemotherapeutic Agent (Melphalan Hydrochloride) Has Started, Do NOT Deflate Balloons Unless Administration of Drug Has Been Stopped And A Full Washout Cycle (30 Minutes) Has Been Completed.

- (d) After the prescribed dose has been fully administered, continue extracorporeal filtration for an additional 30 minutes (washout period).

ENDING EXTRACORPOREAL CIRCULATION

IR **PF**

19. Ending Extracorporeal Circulation

- (a) At the end of the 30-minute wash-out period, deflate the caudal balloon fully.
- (b) Then deflate the cephalad balloon fully.
- (c) Discontinue filtration by reducing the pump RPM to 1000, closing clamps 3 and 9, and then stop flow by turning off the pump.
- (d) A portion of blood in the circuit may be returned to the patient by adding sterile heparinized normal saline into the circuit to flush the blood back into the patient. Open clamps 1 and 2 of the circuit to use the heparinized normal saline from the bags used to prime the circuit. Do not open the bypass line clamps.

CATHETER REMOVAL **IR**

20. Catheter Removal

- (a) Remove the infusion catheter. The 5F arterial sheath should only be removed when coagulation status has been normalized.
- (b) Remove Isofuse® catheter carefully and replace with 18F obturator. Place the obturator completely into the sheath so the obturator hub bottoms out onto the sheath hub. The 18F venous sheath should only be removed when coagulation status has been normalized.

- (c) Close the stopcock or red clamp on the 10F venous return sheath sideport and disconnect the venous return line from the sheath. Do not remove the 10F venous return sheath until coagulation status has been normalized.
- (d) Dispose of all components appropriately in accordance with hospital, local, state, and federal biohazard guidelines.

NORMALIZATION OF COAGULATION STATUS FOR SHEATH REMOVAL

O **IR** **IN**

21. Normalization of Coagulation Status for Sheath Removal

- (a) Administer protamine sulfate by slow intravenous infusion in a dose appropriate to the amount of heparin given and the activated clotting time.
- (b) Administer 10 units of cryoprecipitate and/or Fresh Frozen Plasma based on coagulation profiles to correct remaining abnormalities per institutional guidelines.
- (c) Repeat coagulation profile.
- (d) Correct remaining coagulopathy following institutional guidelines. The following recommendations are provided for consideration:

Coagulation Profile	Action
Prothrombin time greater than 2 seconds of normal	Administer Fresh Frozen Plasma
Partial thromboplastin time greater than 5 seconds of normal	Administer protamine

- (e) Plasma albumin and globulin levels are replenished when Fresh Frozen Plasma is given. If replacement is needed, infuse according to institutional guidelines.
- (f) Measure blood platelet levels to determine if replacement is needed. Follow hospital protocols and transfuse accordingly.
- (g) Follow institutional guidelines for administration of packed red blood cells for anemia.
- (h) All sheaths may be safely removed if the platelet count is greater than 50,000/ mm³ and after the patient's coagulation status has normalized. Compress puncture sites until adequate hemostasis is achieved.
- (i) Dispose of all components appropriately in accordance with hospital, local, state, and federal biohazard guidelines.
- (j) Carefully monitor the patient until complete recovery.

SPECIFICATION OF CLINICAL BENEFIT

This device allows for high dose chemotherapeutic agent (melphalan hydrochloride for injection) to be delivered to the diseased body organ (liver) while minimizing the systemic toxicities of such a high dose. The limitation of standard systemic treatment with a chemotherapeutic agent is that the dose of the chemotherapeutic agent is restricted by the toxicities of the drug as it circulates through the systemic circulation. Additionally, for tumours in the liver, the chemotherapeutic agent has to circulate through the entire systemic circulation to treat the liver. This device overcomes both of those issues by directly targeting the liver and allowing for high dose infusion of the chemotherapeutic agent directly into the liver. After the blood containing the high dose chemotherapeutic agent flows out of the liver, this device's filters remove the majority of the chemotherapeutic agent from the blood prior to returning the blood to the systemic circulation. Thus, the clinical benefit to the patient is that they receive high dose chemotherapeutic agent targeted directly to the diseased liver without the toxicities that would normally be seen. Furthermore, the device allows treatment of the entire liver tissue, including treating any micro lesions that were undetected on radiological imaging. The device has the benefit of being minimally invasive. An additional benefit is that this treatment can be given multiple times.

SAFETY AND CLINICAL PERFORMANCE

The Summary of Safety and Clinical Performance will be available in the European database on medical devices (EUDAMED; <https://ec.europa.eu/tools/eudamed>), where it is linked to the Basic UDI-DI 0850014023CHEMOSAT-HDSXQ. Until EUDAMED is functional, the summary of safety and clinical performance will be provided upon request.

REPORT SERIOUS INCIDENTS

Serious incidents that occur in relation to the device should be reported to Delcath and subsequently to the national competent authority of the country in which the incident occurred.

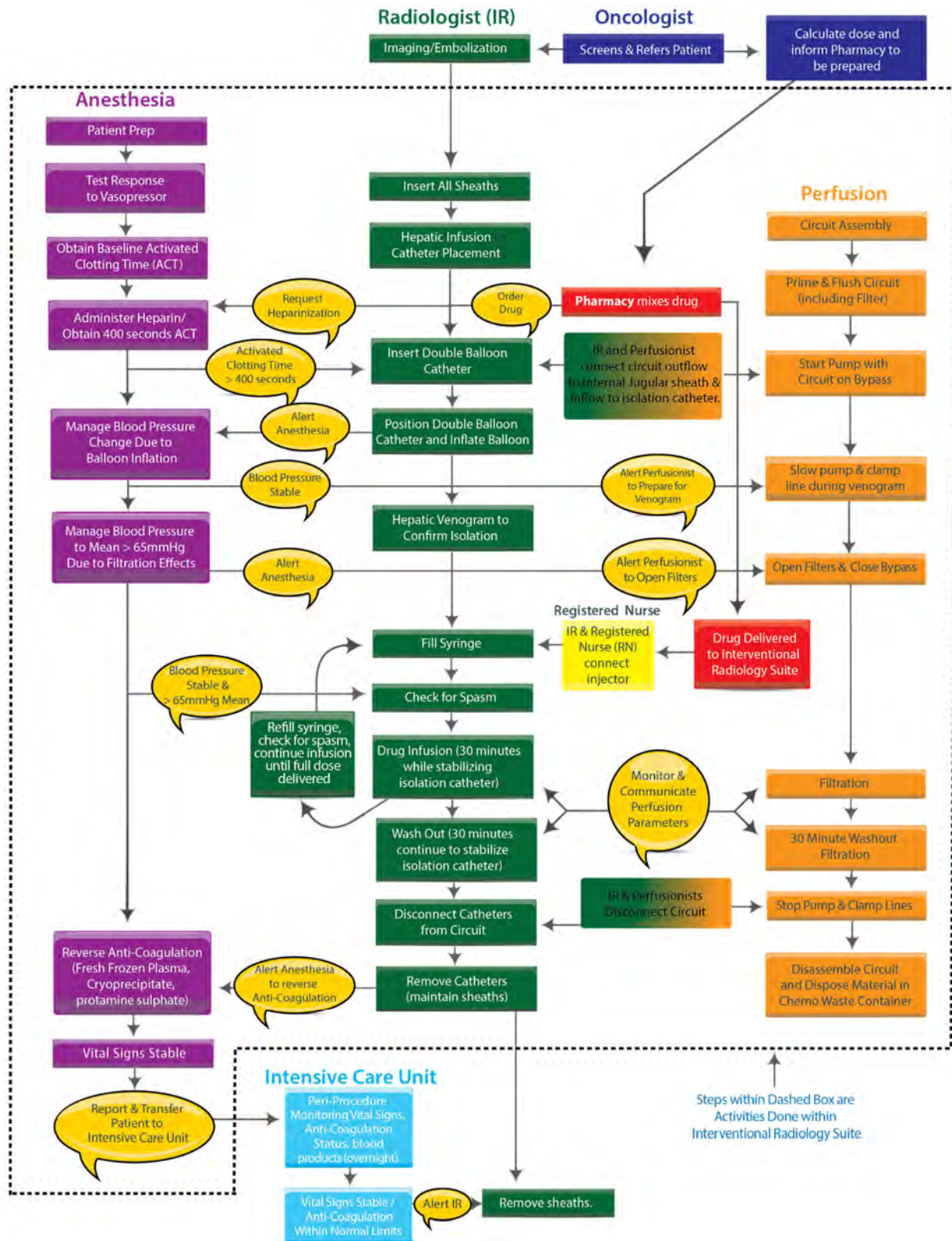

PROCEDURE FLOWCHART - FIGURE 29

LIMITED WARRANTY

Delcath Systems, Ltd. ("Delcath") warrants that the Delcath CHEMOSAT® Hepatic Delivery System ("Product") will be free of defects in material and workmanship at the time of delivery and until the stated expiration date as indicated on the Product. This warranty is available and extended only to the original end-user purchaser of the Product. THE FOREGOING IS DELCATH'S SOLE WARRANTY.

Any Product, or part of the Product, that is judged by Delcath to be defective in material or workmanship during the warranty period will be replaced or repaired by Delcath at its sole option and its expense. Remedies available to the purchaser under this warranty are limited to replacement of the entire Product or malfunctioning parts of Product with the specific remedy subject to determination by Delcath in its sole and reasonable judgement.



















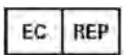







Application for warranty coverage and remedy must be made in writing to Delcath within ten (10) days of the apparent malfunction. All authorized Product returns will be subject to Delcath's Return Goods Policy.

This warranty is void if the Product has been (a) improperly stored or handled; (b) modified, altered or repaired in any way; (c) reused, reprocessed, or re-sterilised; (d) improperly or negligently used or misused; (e) combined or used with a third party's products; or (f) damaged by negligence, accident, or intentional misconduct.

THE FOREGOING WARRANTIES ARE EXCLUSIVE AND IN LIEU OF ANY OTHER WARRANTIES, EXPRESS OR IMPLIED, WITH RESPECT TO THE GOODS SOLD HEREUNDER. EXCEPT AS EXPRESSLY PROVIDED HEREIN, DELCATH MAKES NO WARRANTY OF ANY KIND, EXPRESS OR IMPLIED, ORAL, WRITTEN OR OTHERWISE, WITH RESPECT TO THE PRODUCT(S) SOLD HEREUNDER, INCLUDING, BUT NOT LIMITED TO, ANY IMPLIED WARRANTIES OF MERCHANTABILITY AND FITNESS FOR A PARTICULAR USE OR PURPOSE. DUE TO BIOLOGICAL DIFFERENCES IN HUMAN PATIENTS AND BECAUSE DELCATH HAS NO CONTROL OVER THE CONDITIONS UNDER WHICH ITS PRODUCTS ARE USED, DIAGNOSIS OF THE PATIENT, TYPE OF TREATMENT, SURGICAL PROCEDURE, THE METHOD OR ADMINISTRATION OF THE PRODUCT OR THE STORAGE AND HANDLING OF THE PRODUCT AFTER IT LEAVES DELCATH'S POSSESSION, DELCATH DOES NOT WARRANT EITHER A GOOD EFFECT OR AGAINST ILL EFFECT FOLLOWING THE USE OF THE DELCATH PRODUCT AND DELCATH MAKES NO WARRANTY AS TO WHETHER OR NOT ANY PARTICULAR OR DESIRED RESULT IS OBTAINABLE BY APPLICATION OR USE OF THE DELCATH PRODUCT.

DELCATH SHALL UNDER NO CIRCUMSTANCES BE LIABLE TO THE PURCHASER OR ANY THIRD PARTY FOR SPECIAL, INDIRECT, INCIDENTAL, PUNITIVE, CONSEQUENTIAL OR EXEMPLARY DAMAGES OF ANY NATURE, WHATSOEVER, INCLUDING, BUT NOT LIMITED TO, COMMERCIAL LOSS FROM ANY CAUSE, BUSINESS INTERRUPTION OF ANY NATURE, LOSS OF PROFITS OR REVENUE, REAL OR PERCEIVED LOSS OF USE, LOSS ARISING FROM A DEFECT IN DESIGN, MATERIAL AND/OR MANUFACTURE OR WORKMANSHIP AND/OR THE FAILURE OF THE PRODUCT(S) TO PERFORM AS SPECIFIED, EVEN IF DELCATH SHALL HAVE BEEN ADVISED TO THE POSSIBILITY OF SUCH DAMAGES.

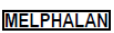
IT IS REQUIRED THAT THE DELCATH PRODUCT BE OPERATED BY OR UNDER THE IMMEDIATE, DIRECT SUPERVISION OF A LICENSED PHYSICIAN OR OTHER LICENSED HEALTHCARE PROFESSIONAL QUALIFIED TO USE THE PRODUCT AND PERFORM THE PROCEDURE. DELCATH DISCLAIMS LIABILITY FOR ALL INJURIES, DEATHS, OR PROPERTY DAMAGE ARISING FROM THE USE OF THE PRODUCT BY ANYONE, OTHER THAN QUALIFIED PERSONNEL DESCRIBED ABOVE, OR THE IMPROPER, NEGLIGENT OR RECKLESS USE OF THE PRODUCT, OR THE USE OF THE PRODUCT FOR ANY UNAPPROVED INDICATION OR FOR ANY USE NOT SPECIFICALLY INDICATED IN THE INSTRUCTIONS FOR USE FOR THE PRODUCT.

	Catalog No.		Use By
	Do not resterilize.		Batch Number
	Medical Device		Keep Dry
	Non-harmonized Symbol Designating 'Contents' of the components within the kit		Do Not Reuse
	Authorized Representative in the European Community		Contains or presence of natural rubber latex
	Keep Away From Sunlight		Contains or presence of phthalate: bis (2-ethylhexyl) phthalate (DEHP)
	Non-pyrogenic		Federal Law (USA) restricts this device to sale by or on the order of a physician
	Manufacturer		Consult Instructions For Use
	Do not use if package is damaged		Electronic Instruction For Use
	Double sterile barrier system		Sterilized using ethylene oxide
	Single sterile barrier system with protective packaging inside		Sterilized using steam or dry heat
	Single sterile barrier system		Non-harmonized Symbol: GW = Guide Wire This symbol is used to highlight the location measurements of the guide wire.
	Date of Manufacture		Non-harmonized Symbol: This symbol is used to highlight when melphalan is being considered in the use of the kit
	Unique device identifier		

THIS PAGE INTENTIONALLY LEFT BLANK



Delcath Systems, Inc.
566 Queensbury Avenue
Queensbury, NY 12804
USA

Customer Service

Phone: +353 91 746200
Fax: +353 91 746208

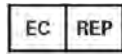

Importer
Delcath Systems Limited
Unit 19 Mervue Industrial Estate
Mervue, Galway IRELAND H91 EP89

CE2797



Recyclable
Package

Delcath is a registered trademark of Delcath Systems, Inc.
CHEMOSAT®, ISOFUSE® and CHEMOFUSE® are registered trademarks of Delcath Systems, Inc.
© 2023 Delcath Systems, Inc. All rights reserved.
Medtronic's Bio-Console® 560 Speed Controller System, is a registered trademark of Medtronic Inc.